

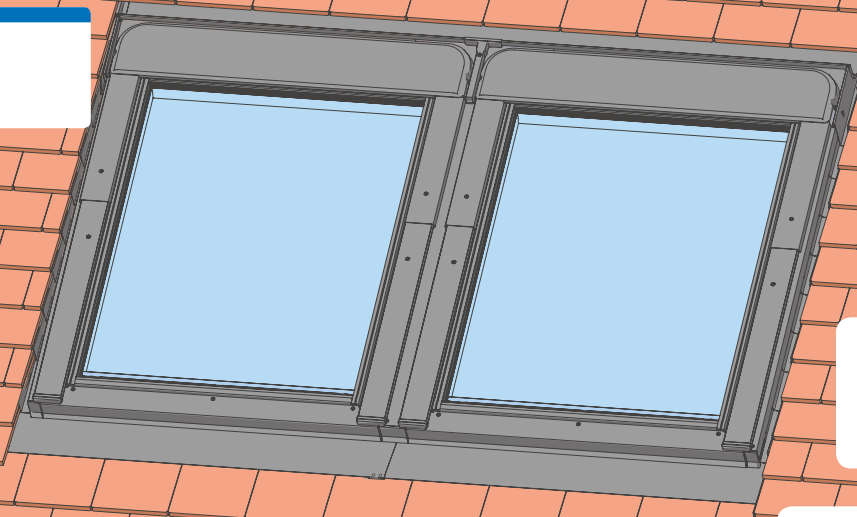

## C-PTRF 18

## ST 18



max 15 mm

25-90°

Futuretherm Technology™

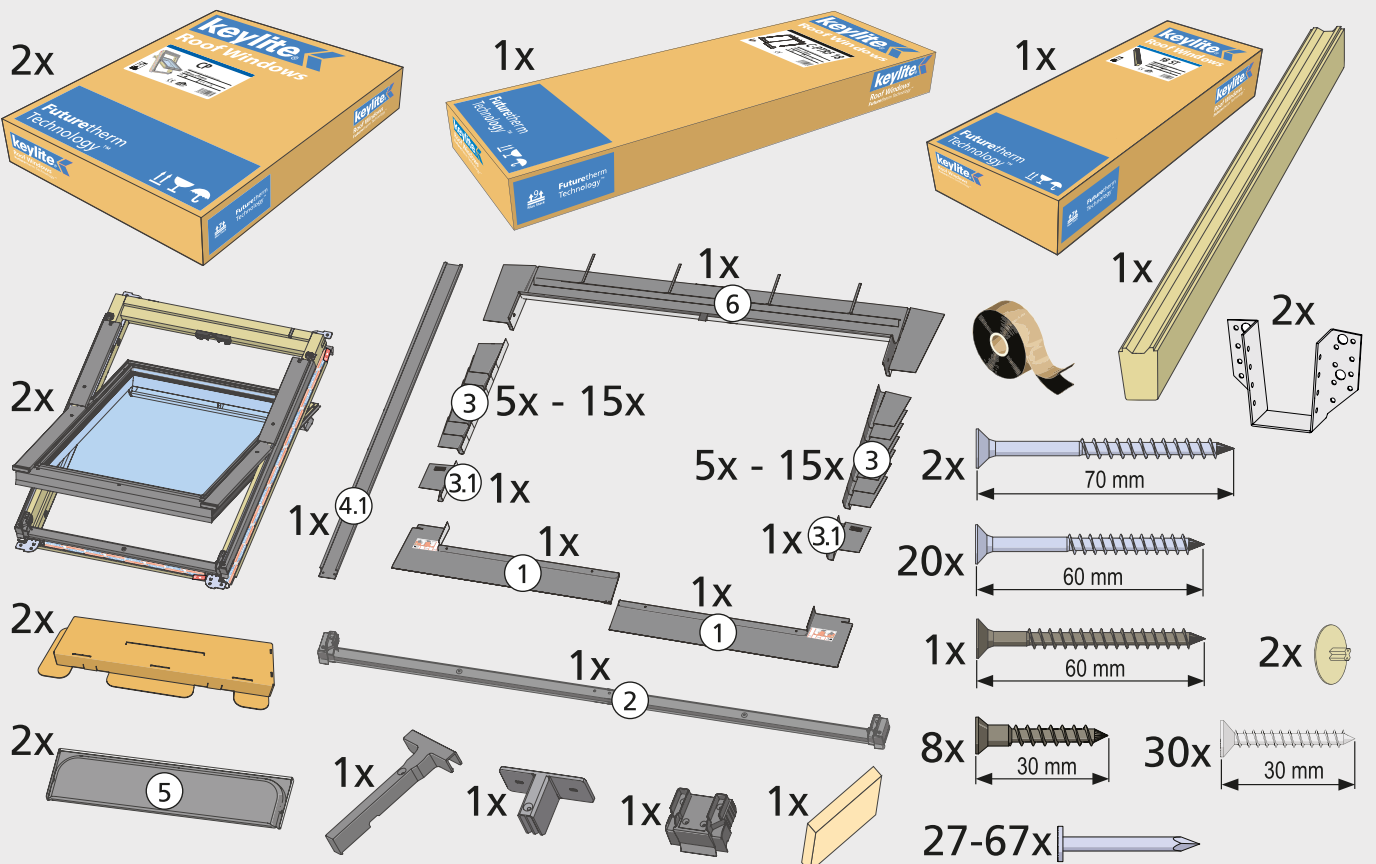



$Z = 100 \text{ mm}$

max 15 mm

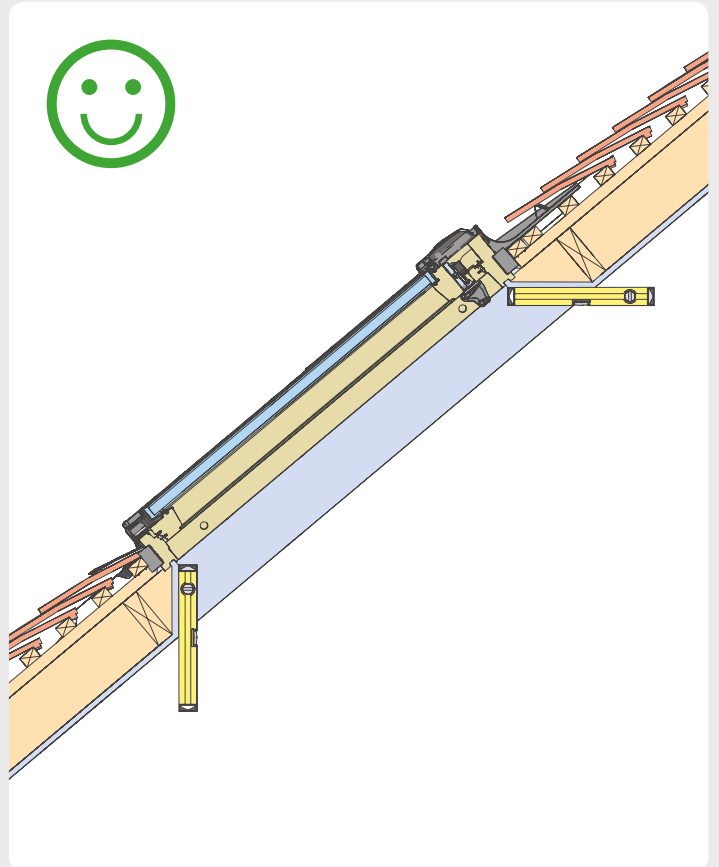
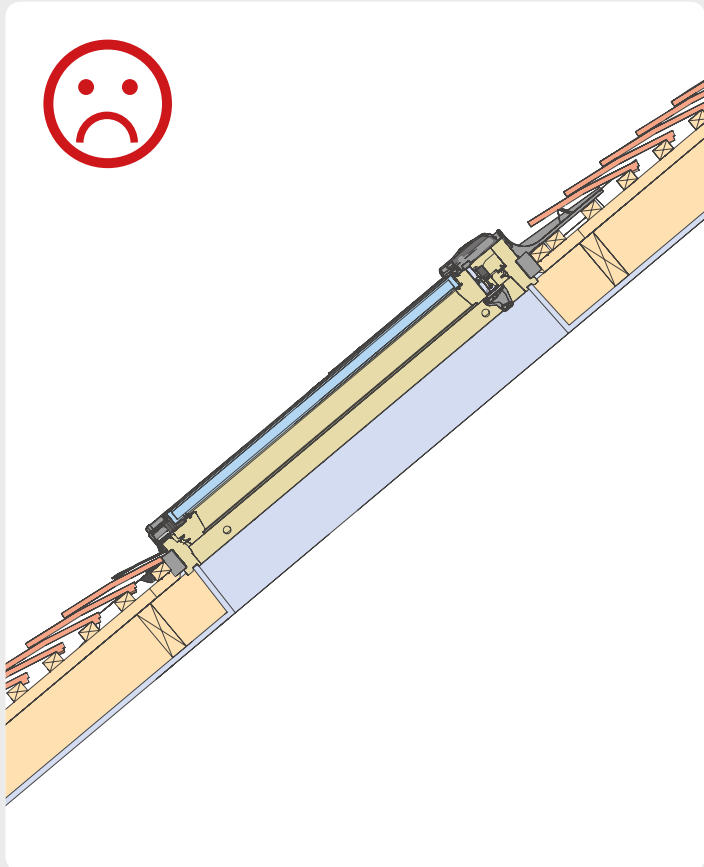
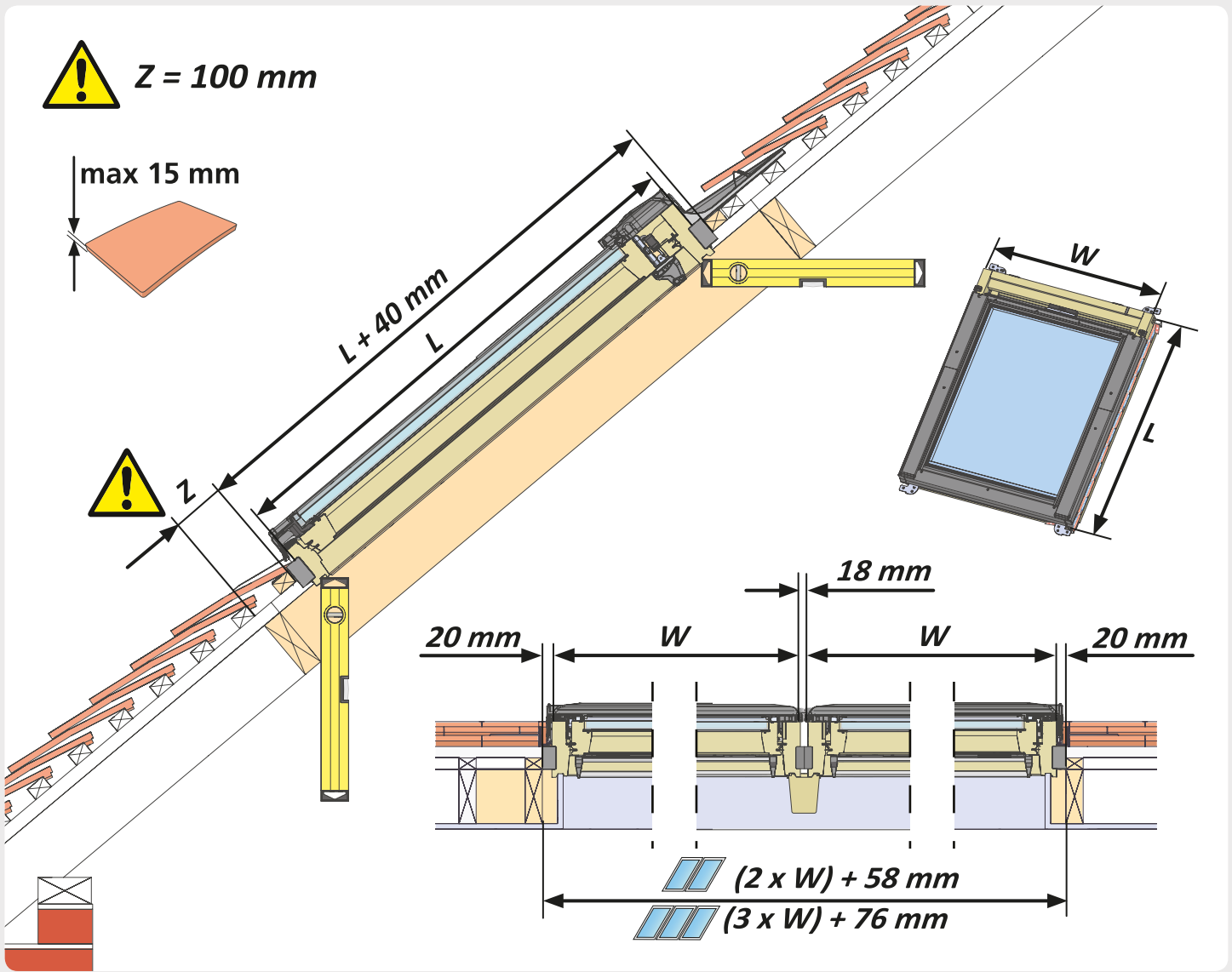
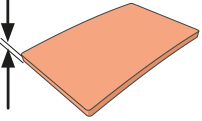

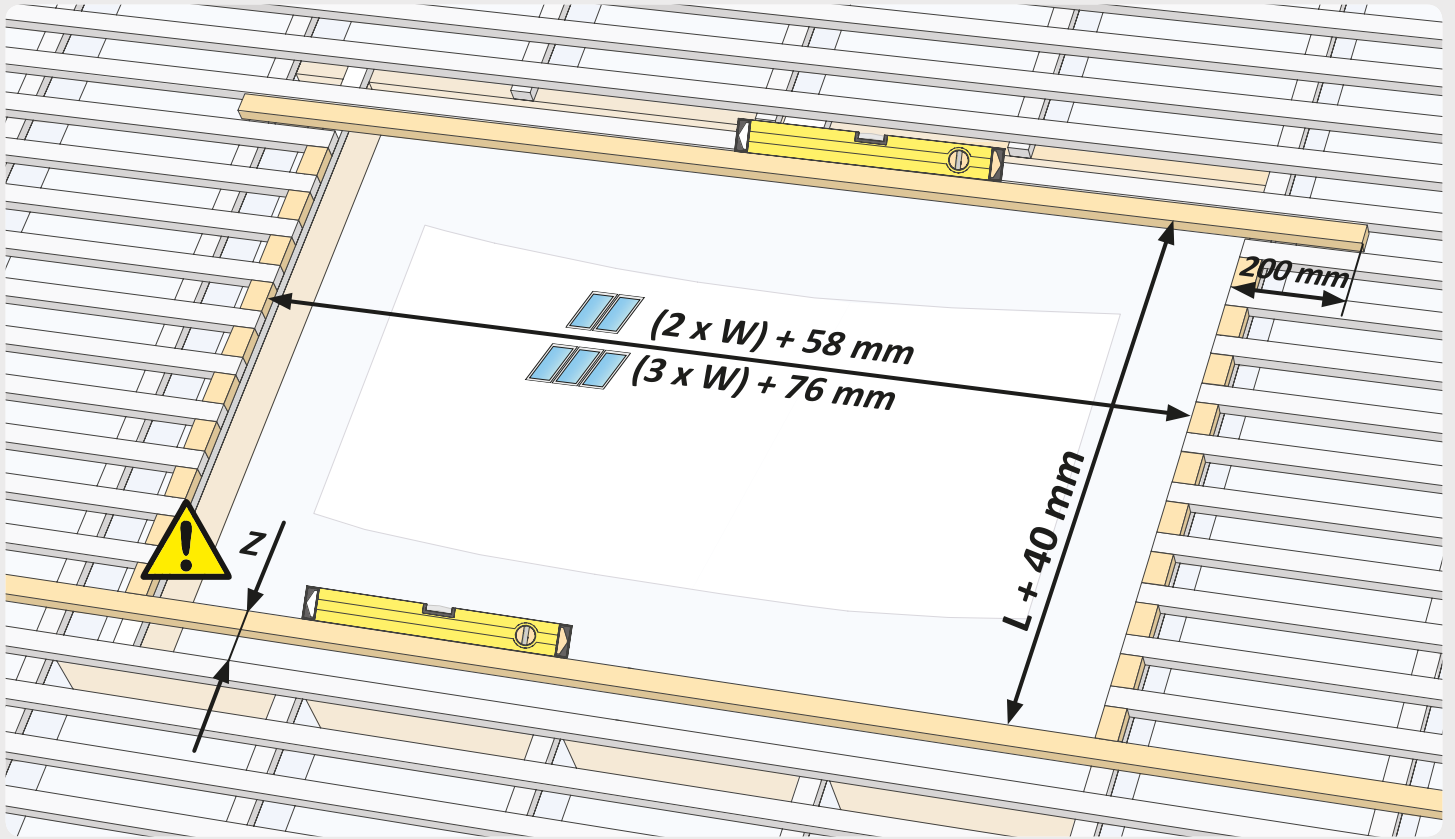

1

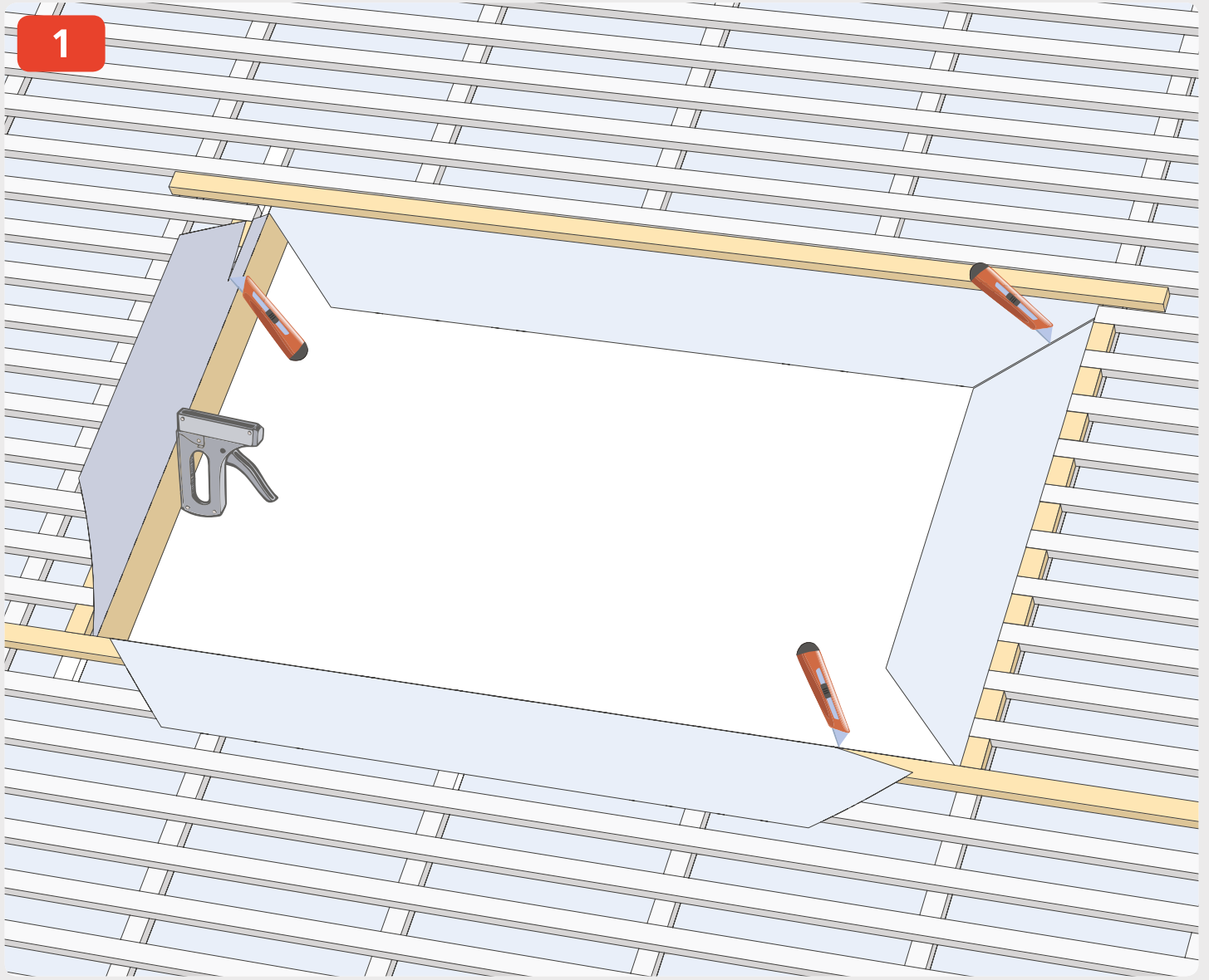

2a

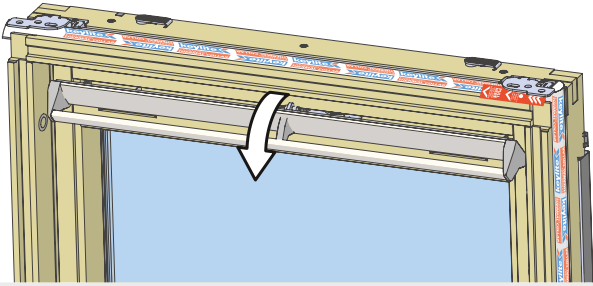

2b

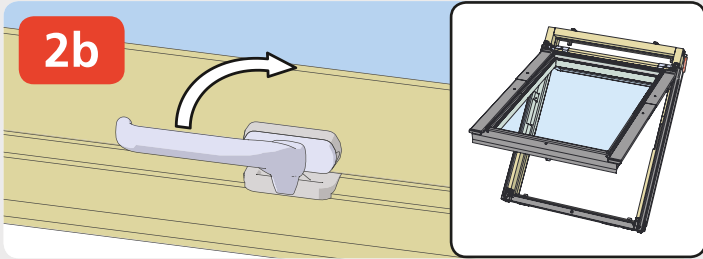

3

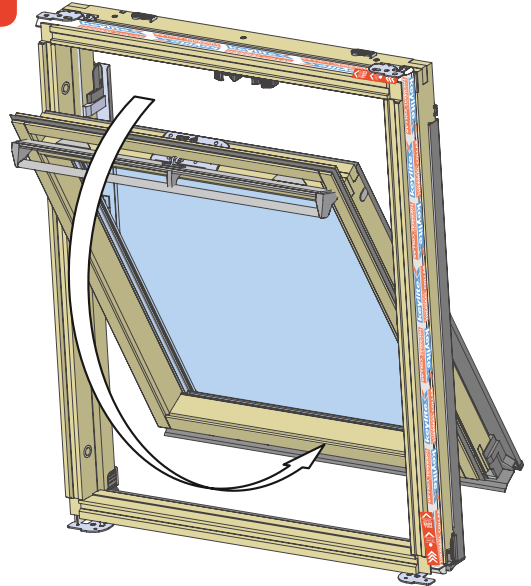

4

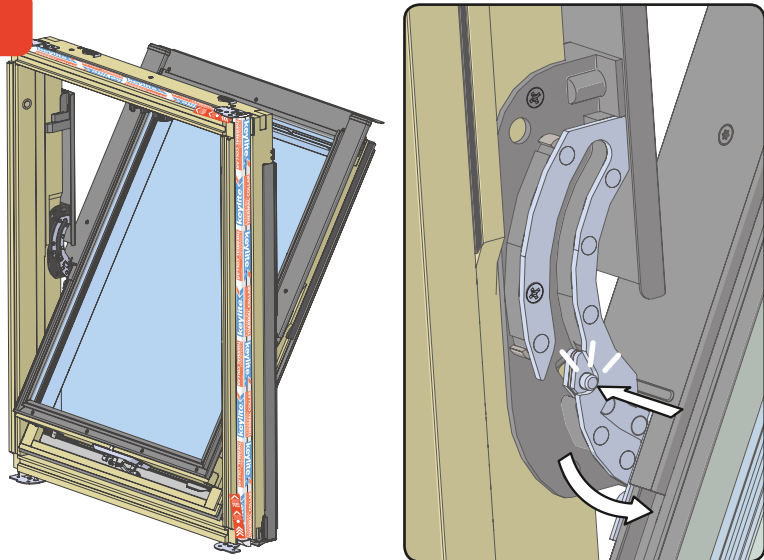

5

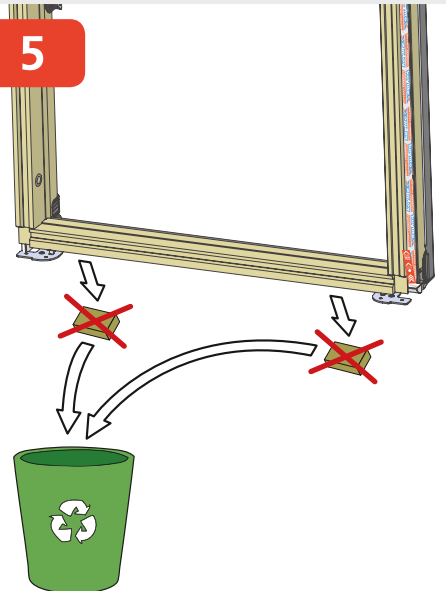

6

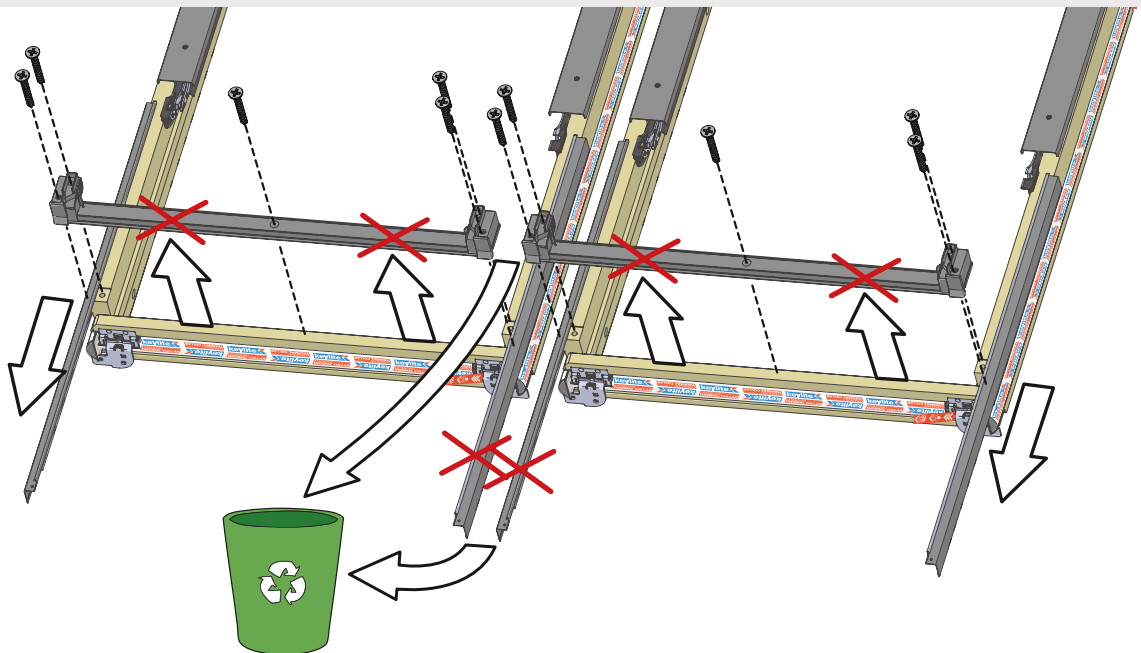

7

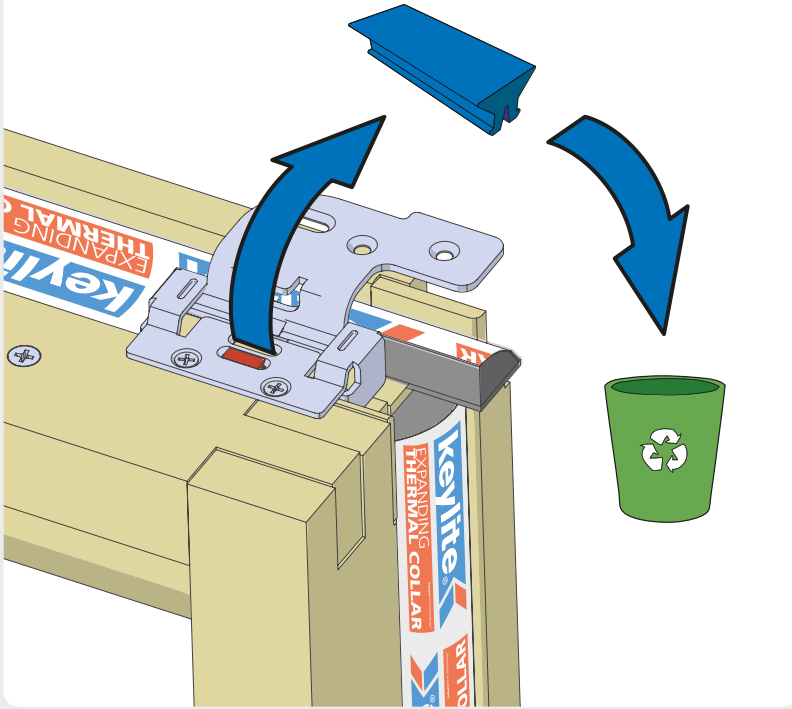

8

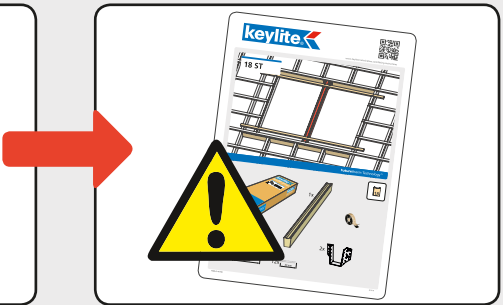
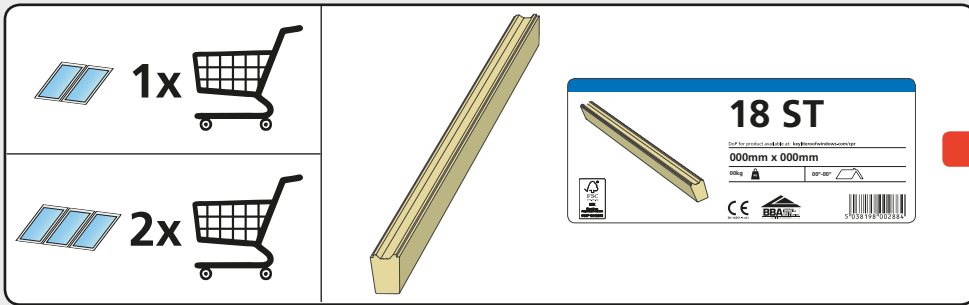
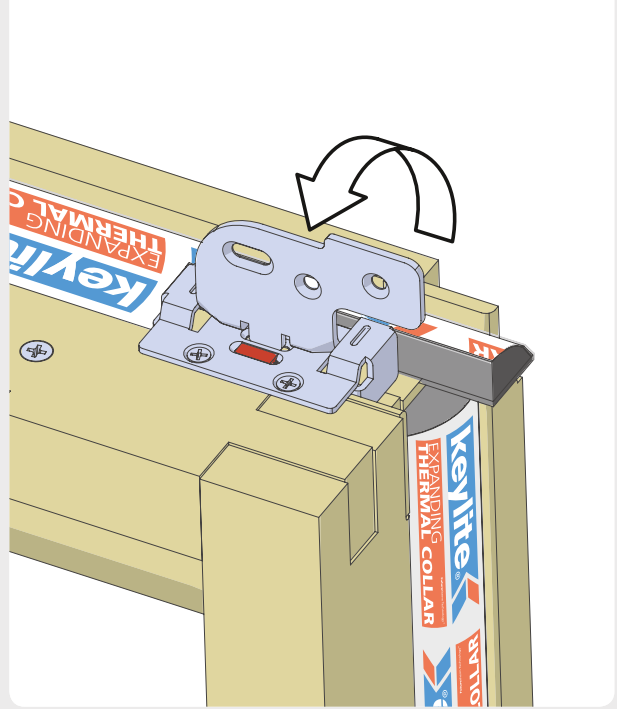

9

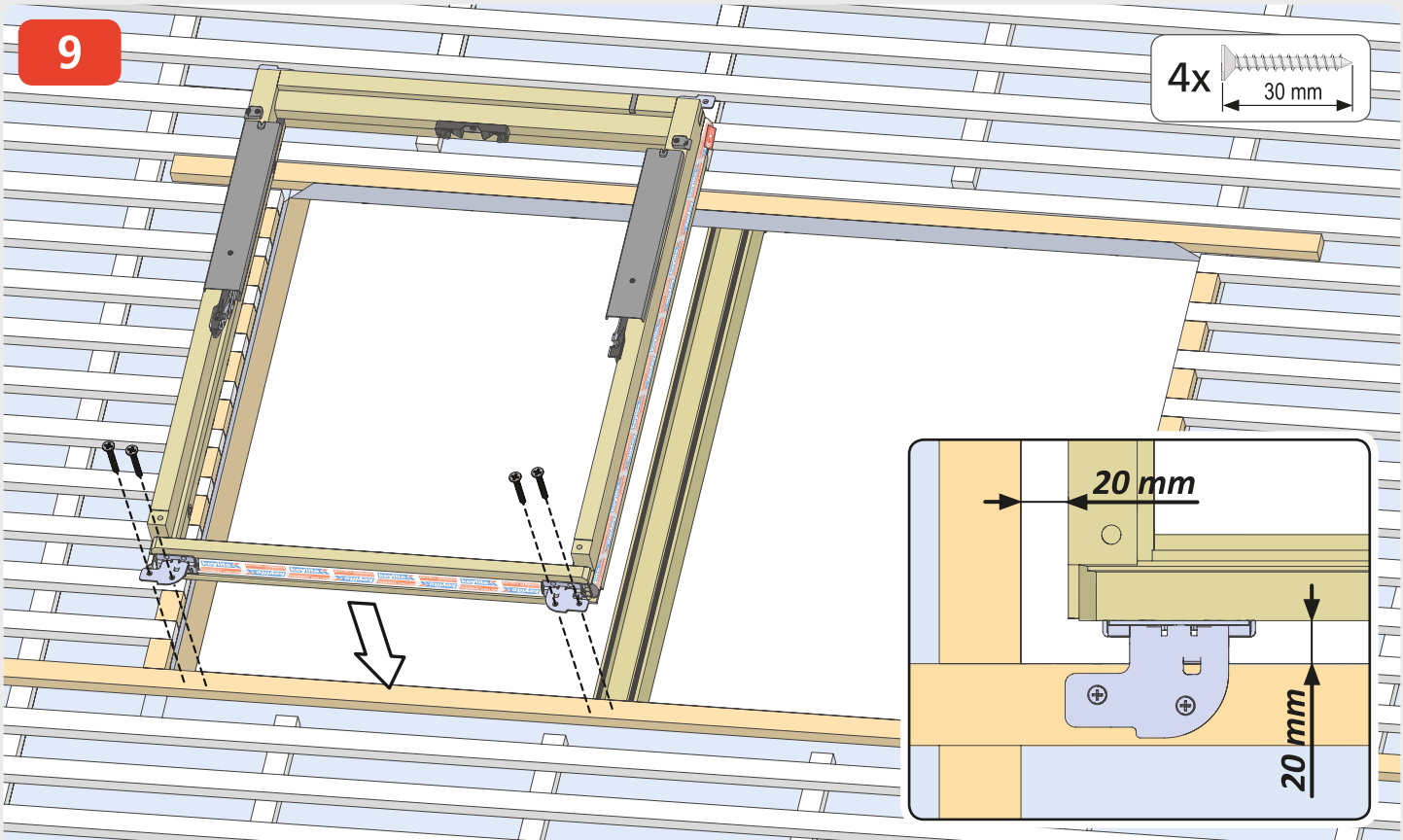

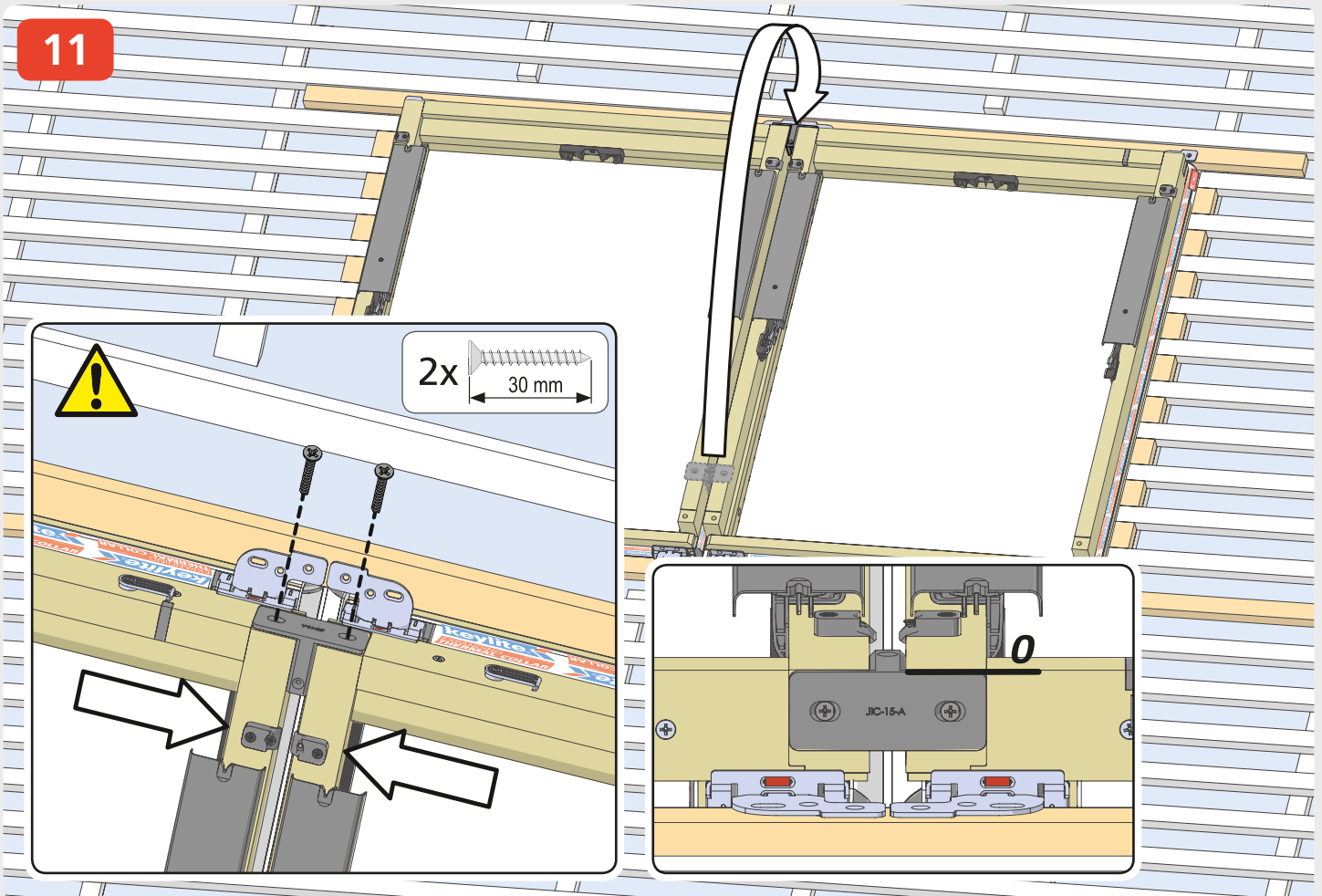
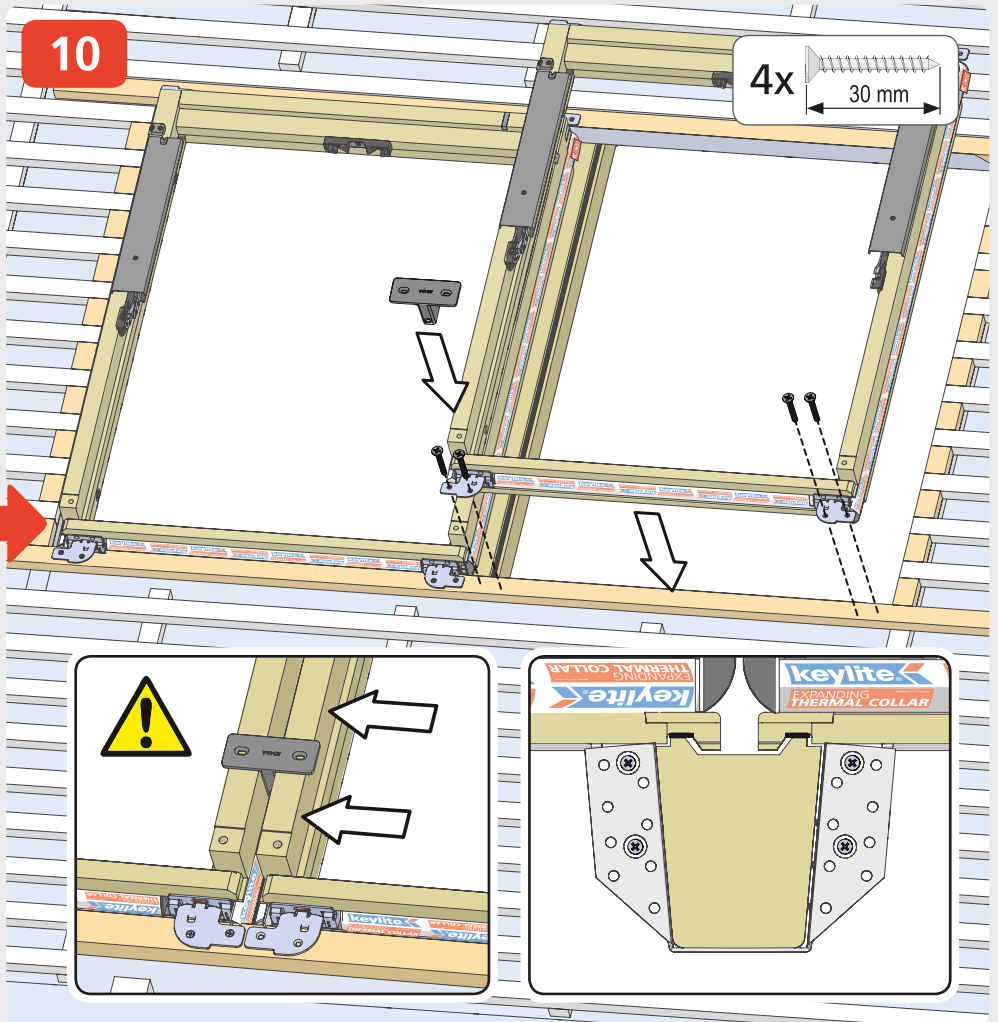
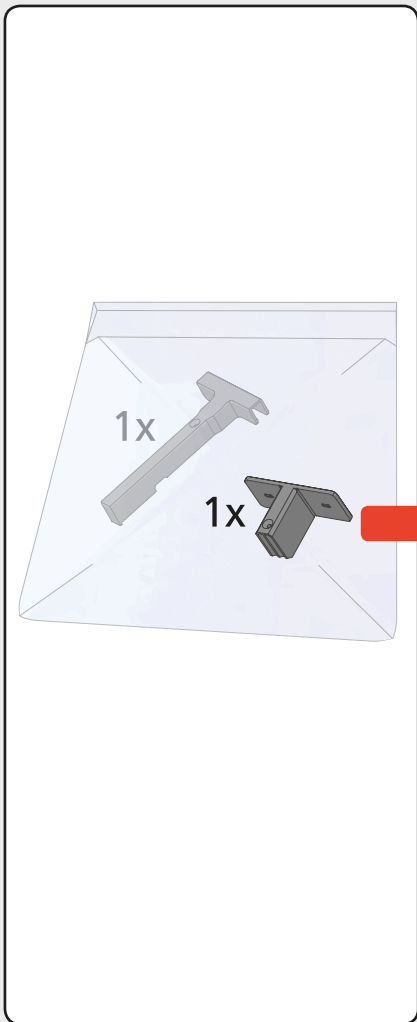

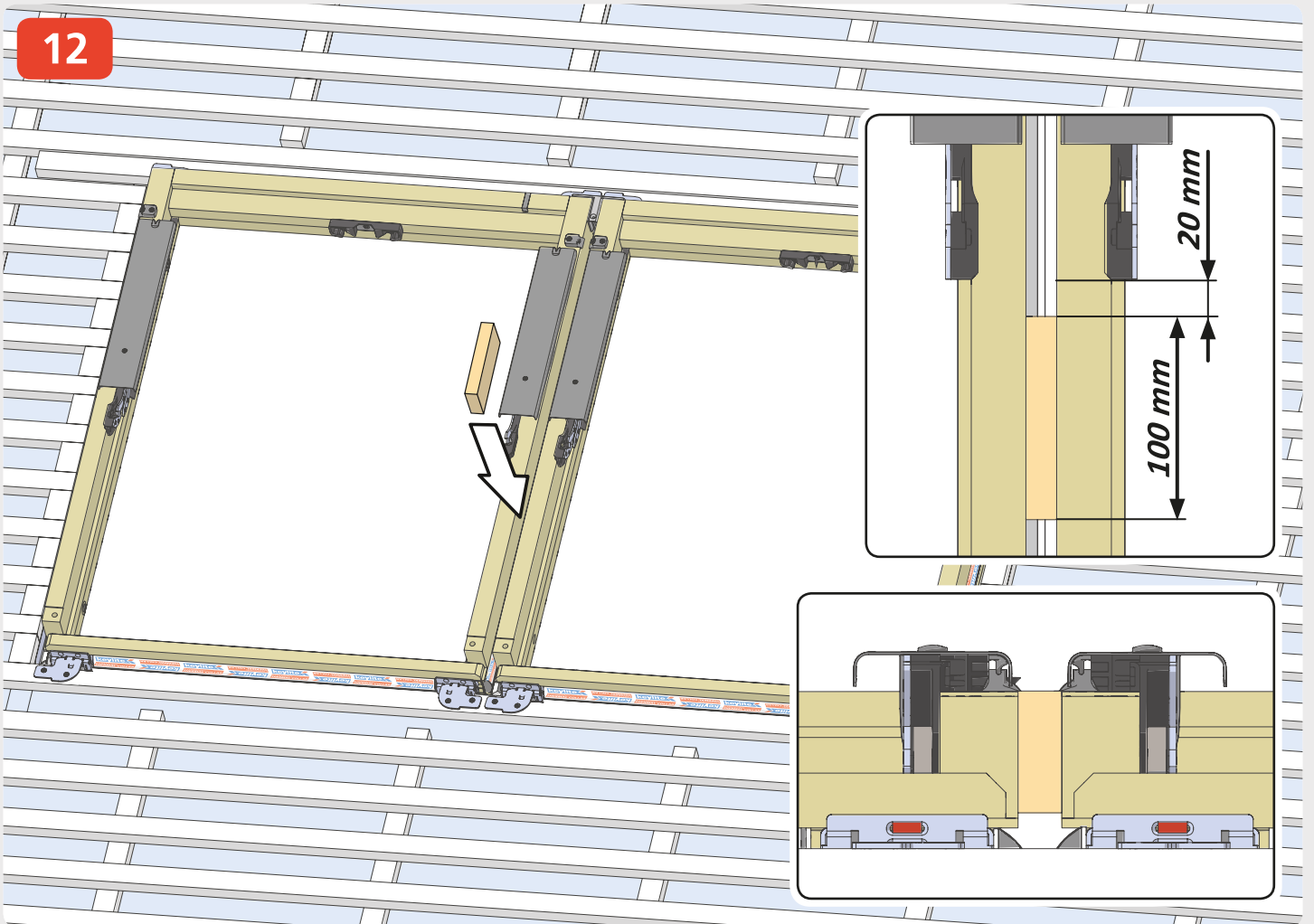

12

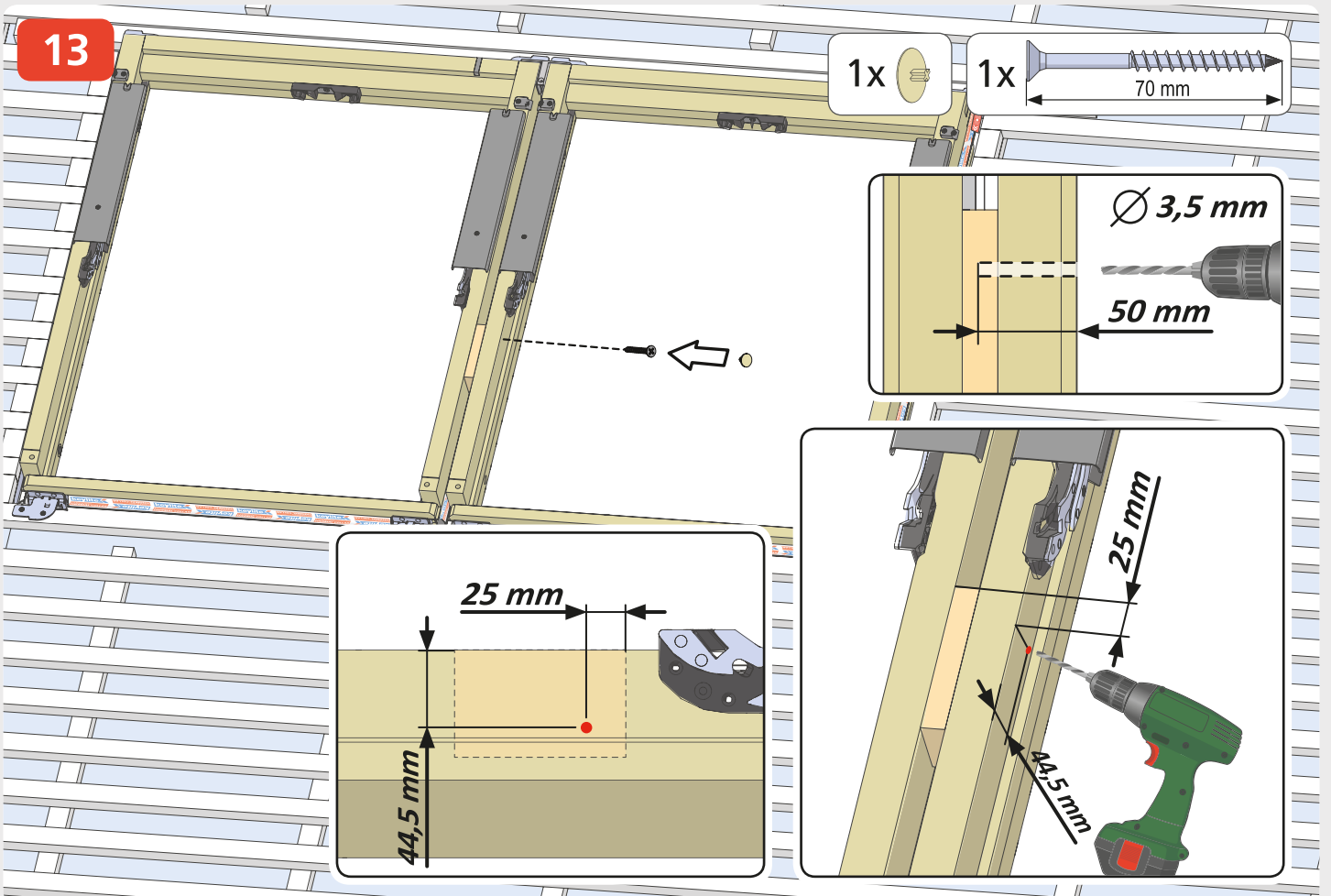

13

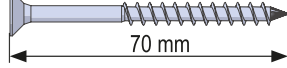

14

1x  1x  70 mm

$\varnothing$  3,5 mm  
50 mm

25 mm  
44,5 mm

44,5 mm  
25 mm

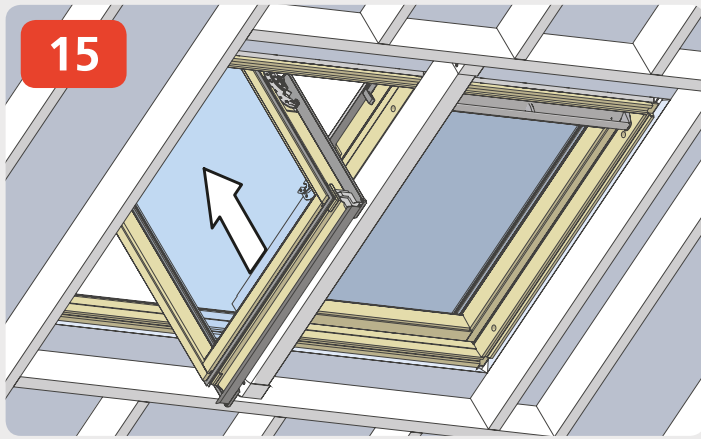

15

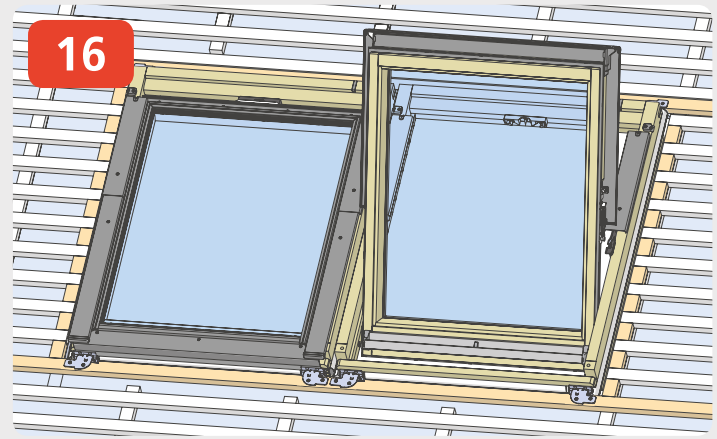

16

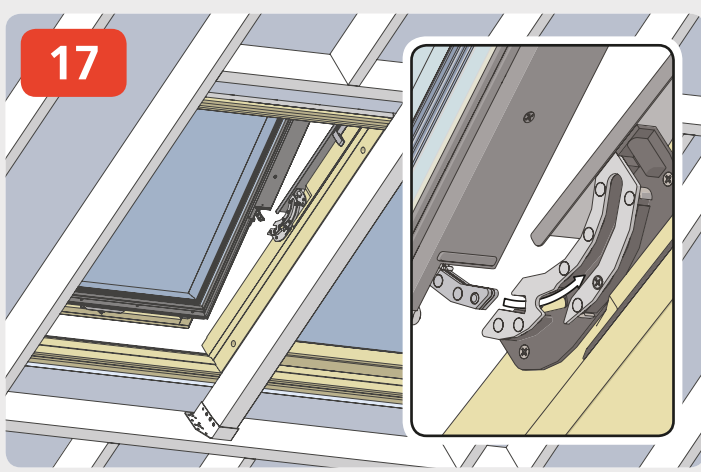

17

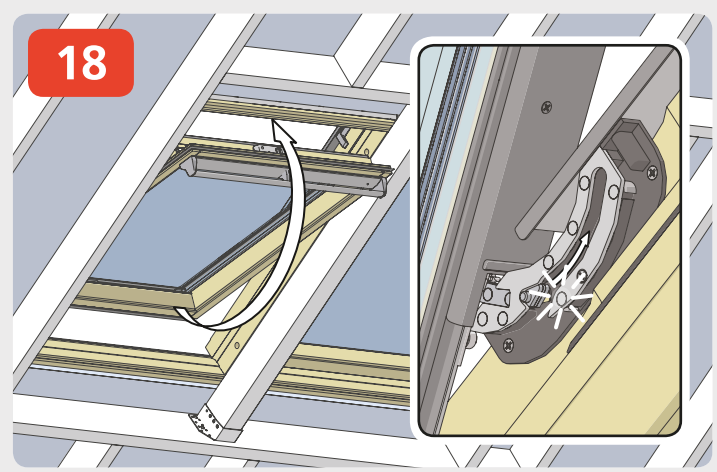

18



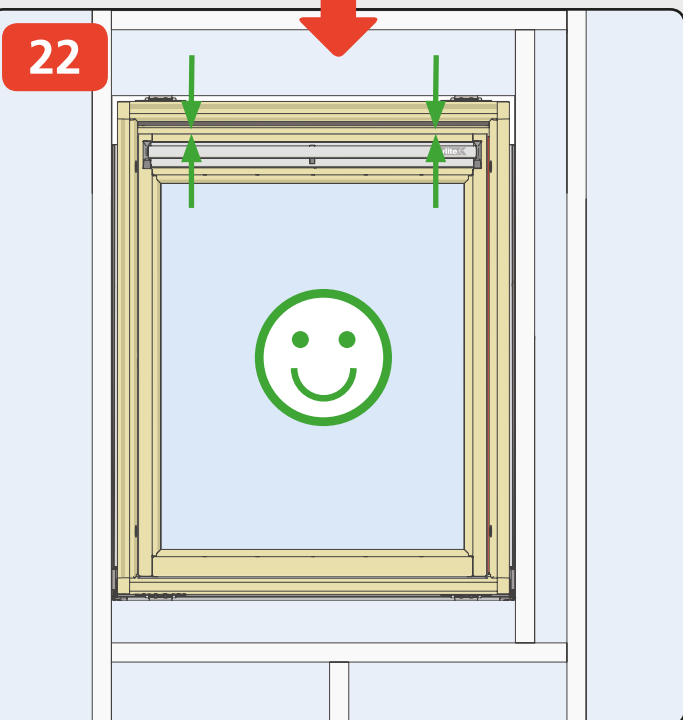
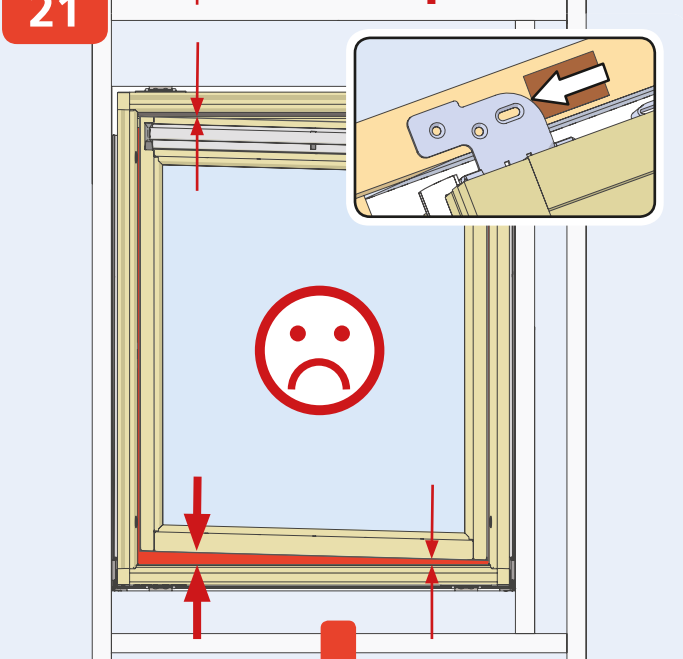
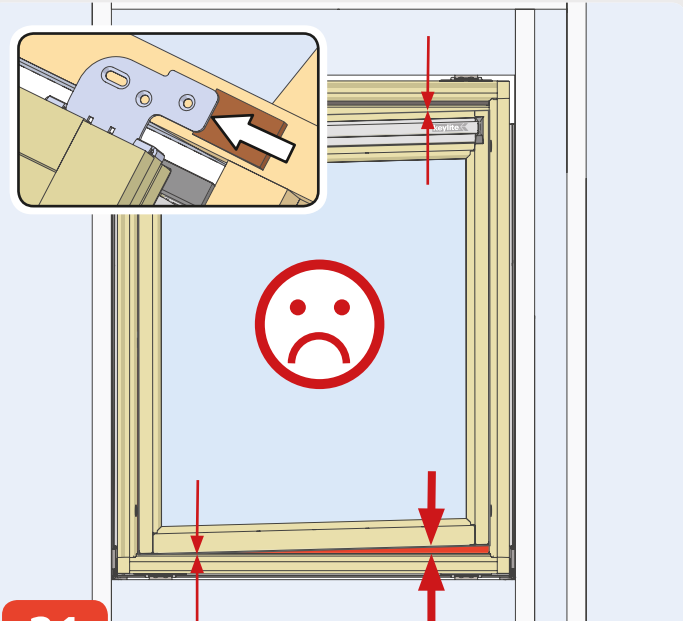
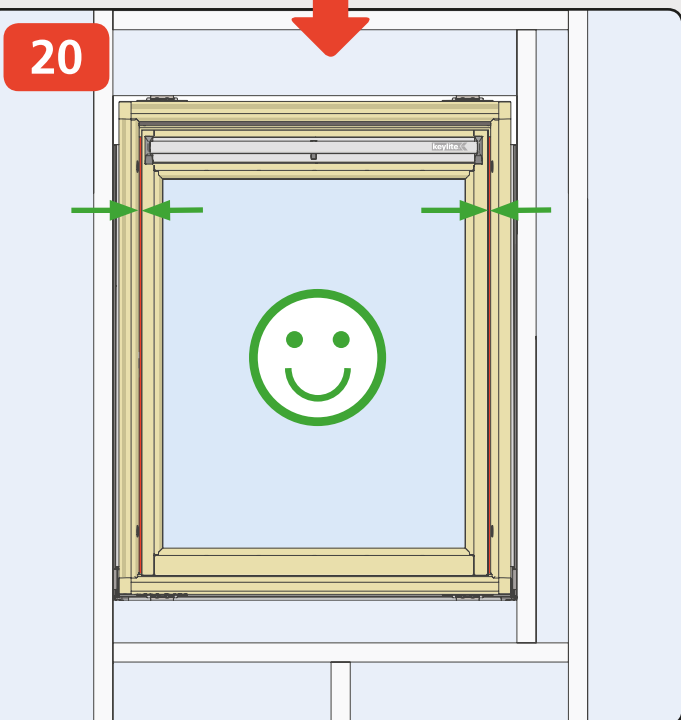
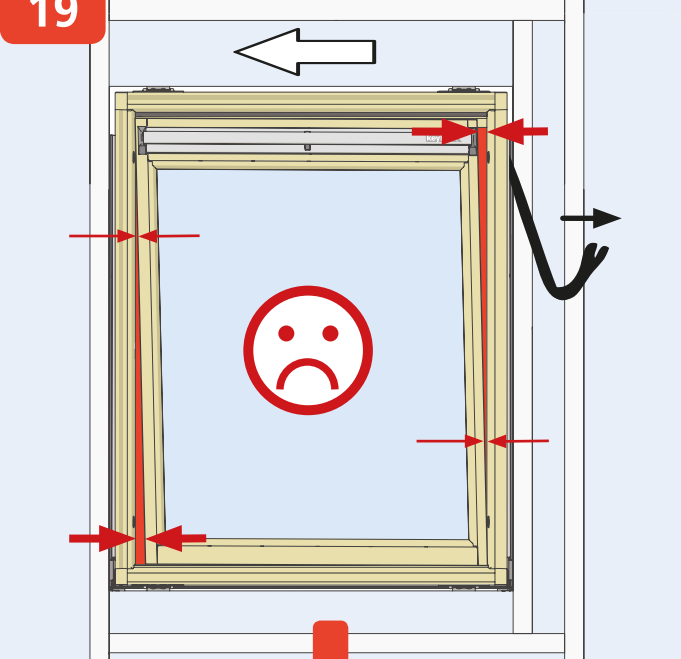
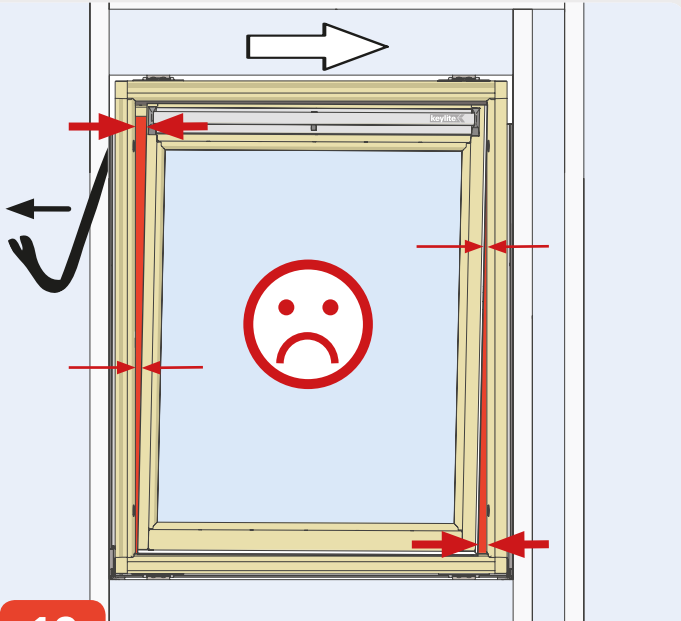

23

8x 30 mm

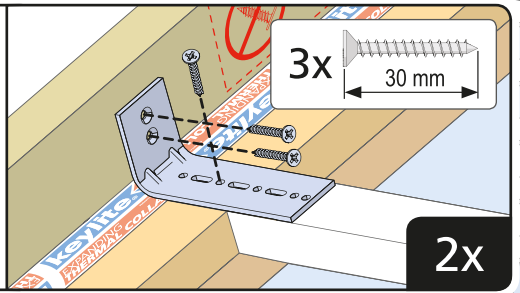
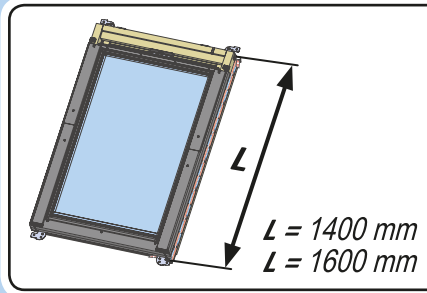
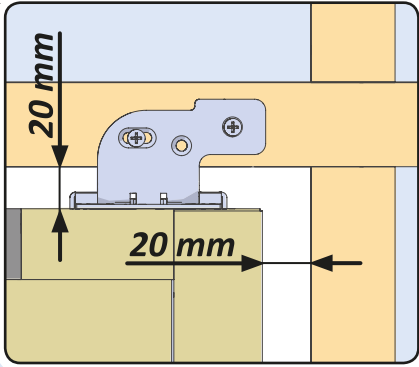

2x

24

12x 60 mm

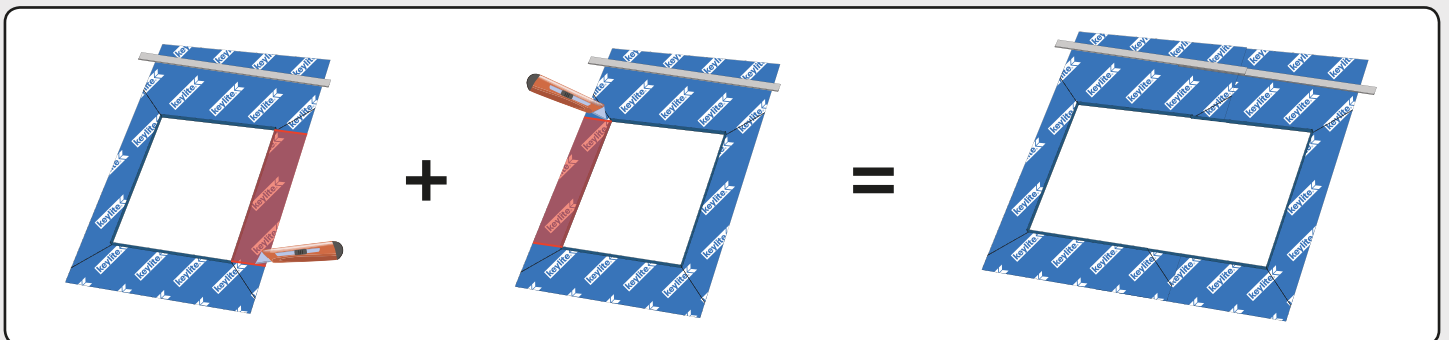
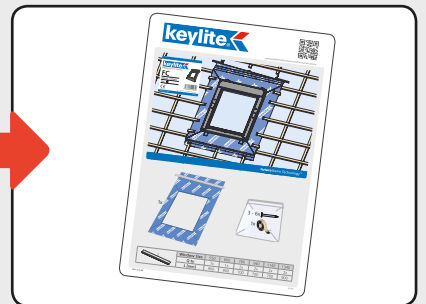
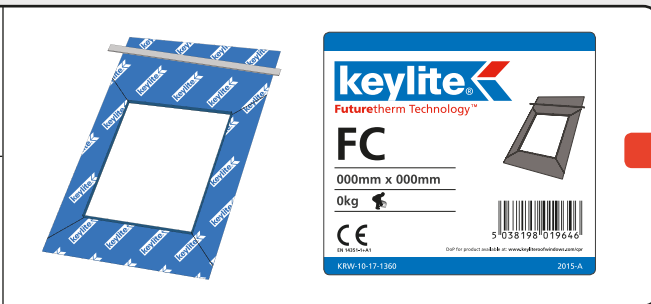
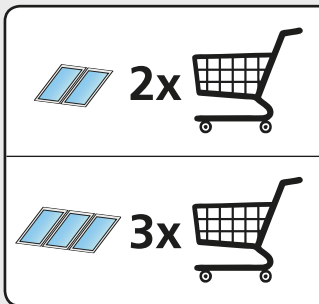
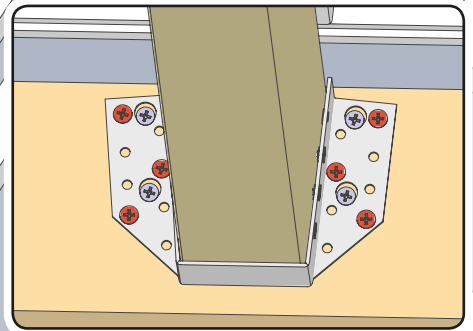
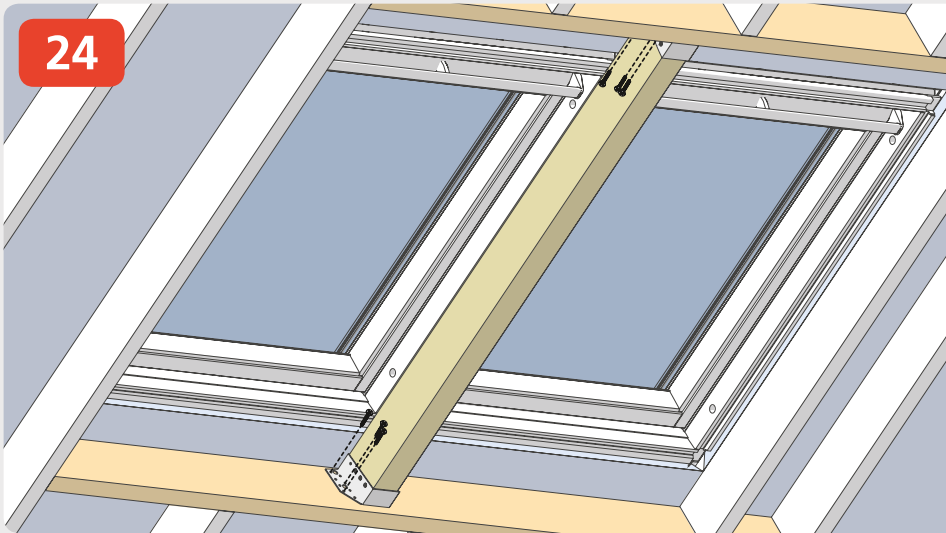

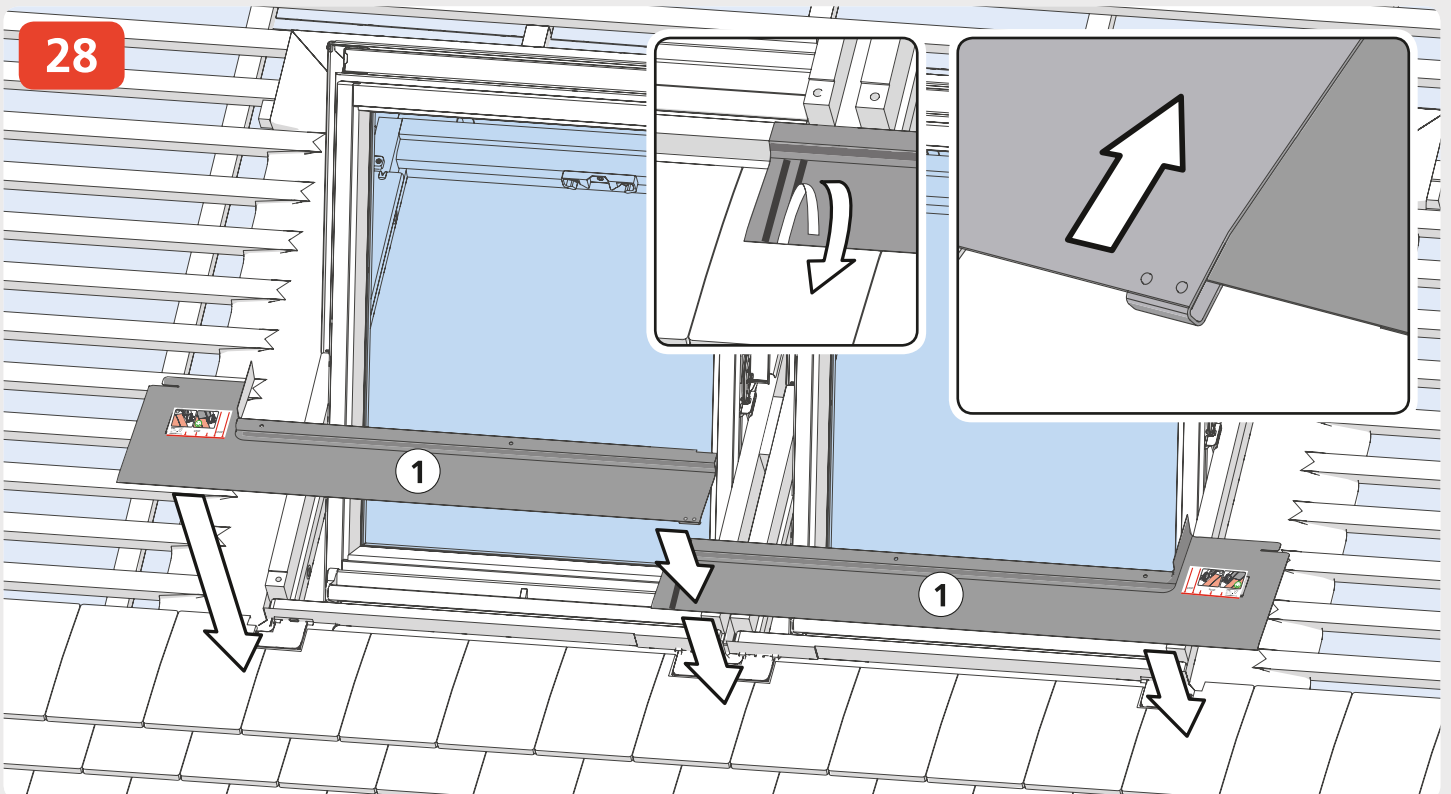
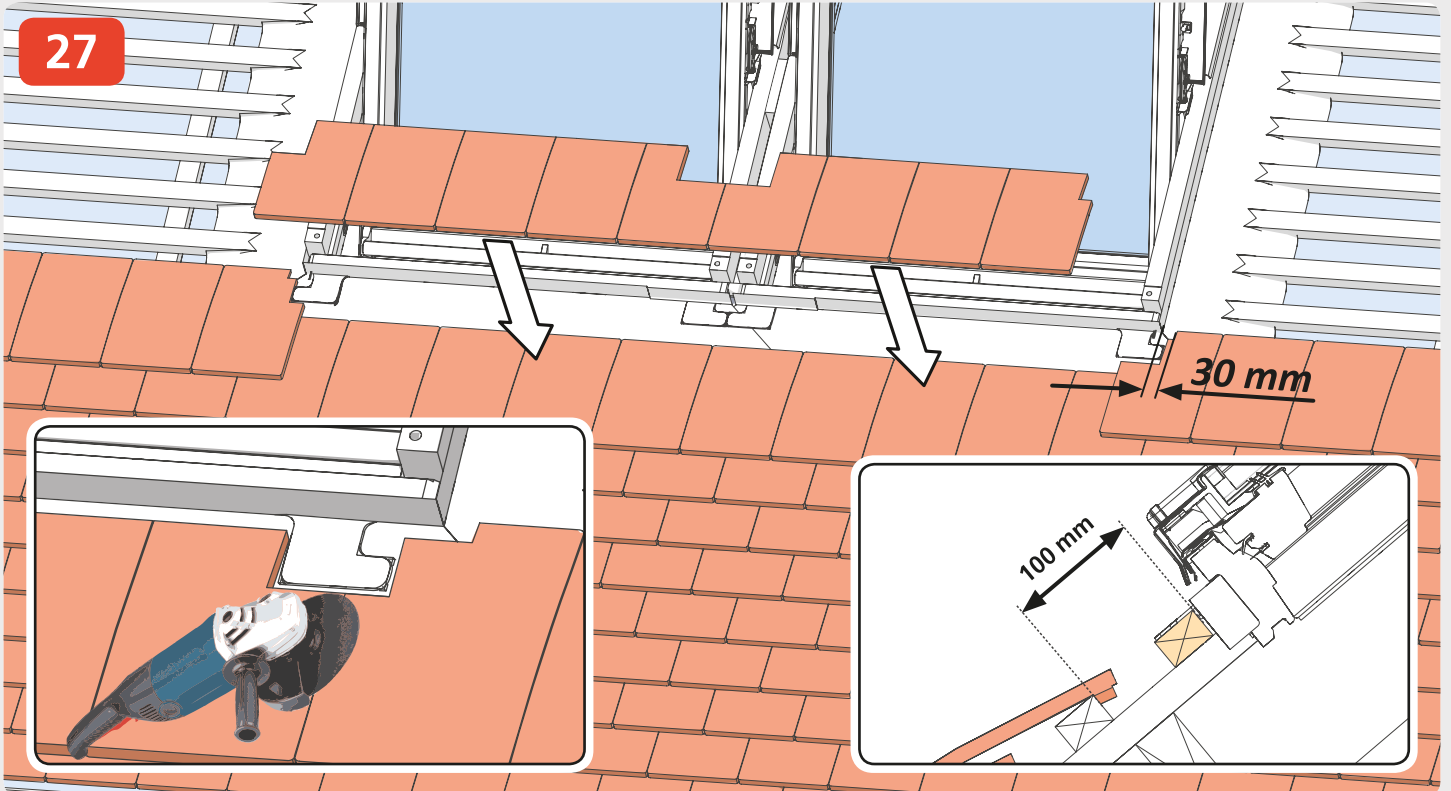
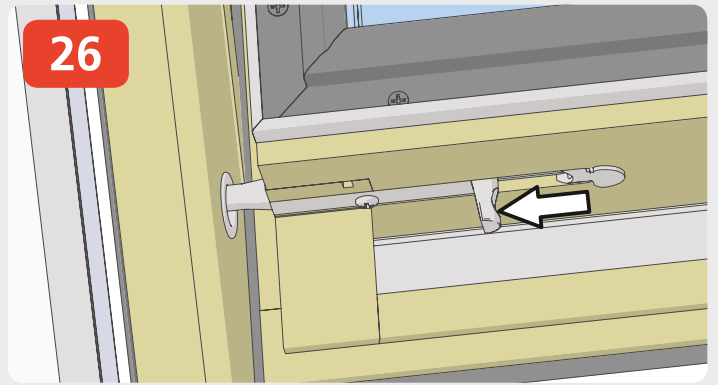
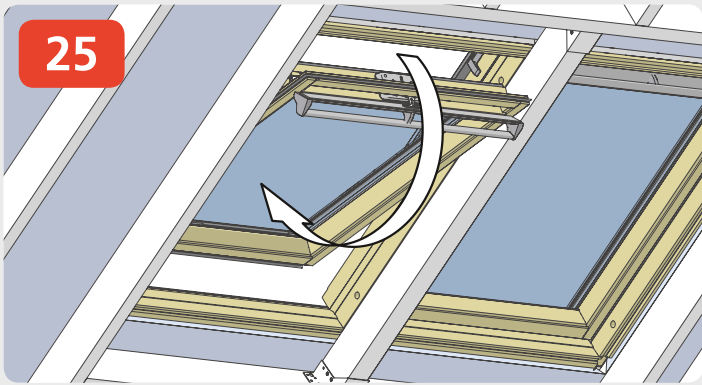

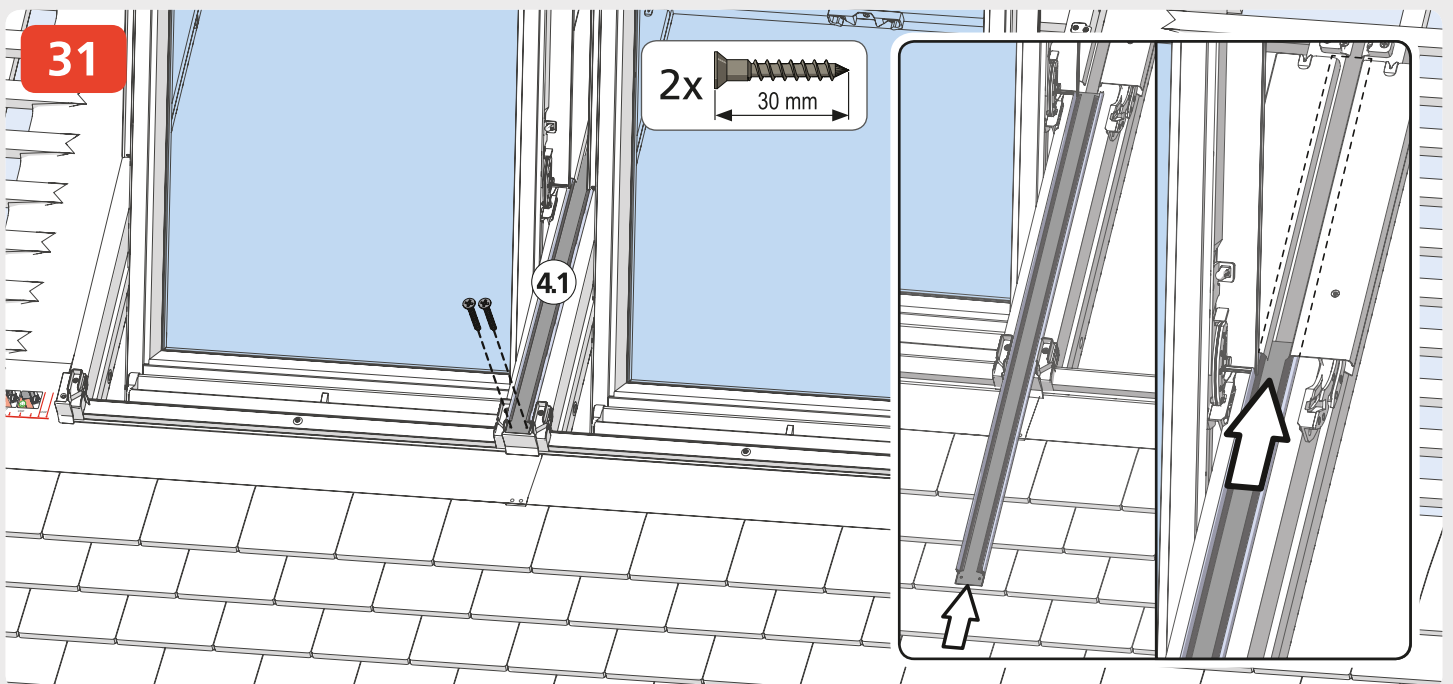
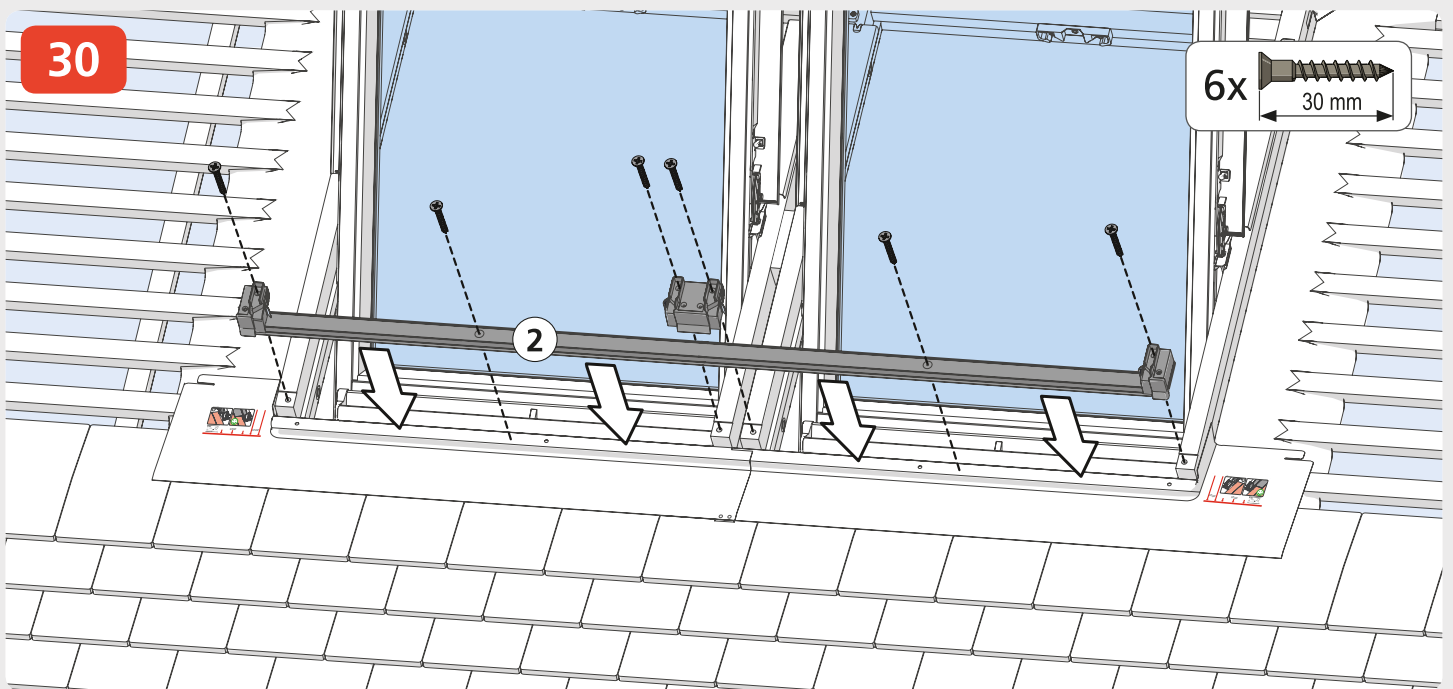
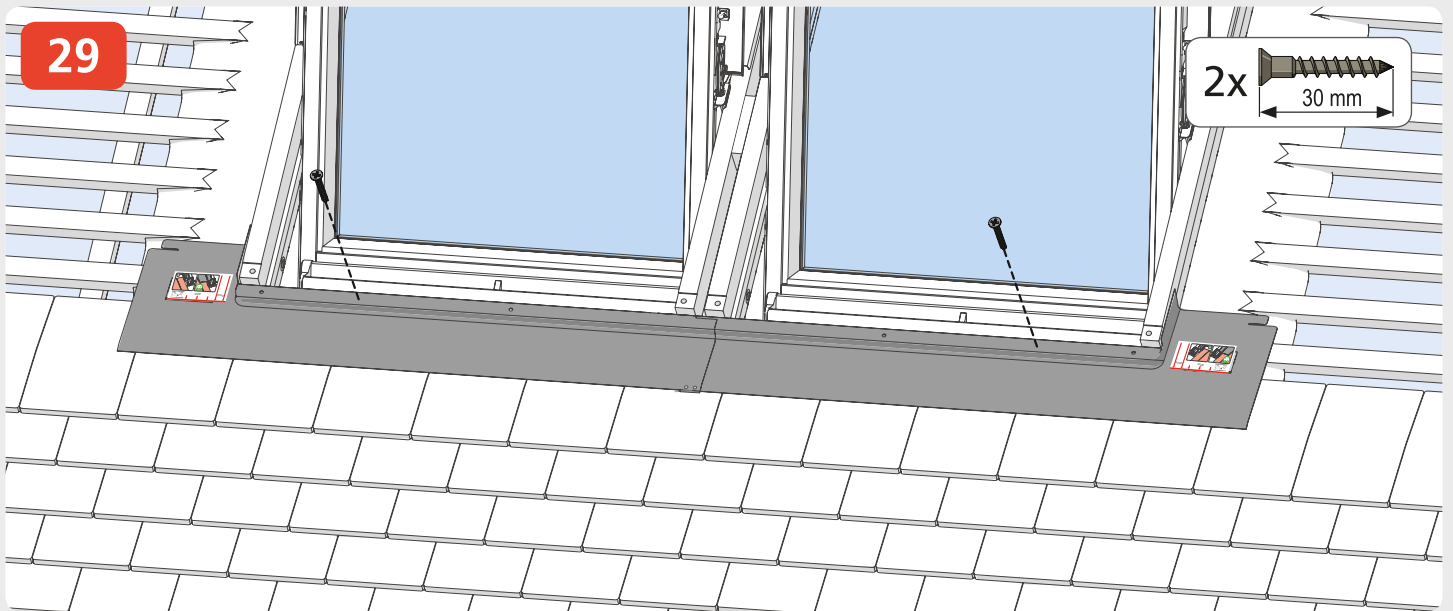

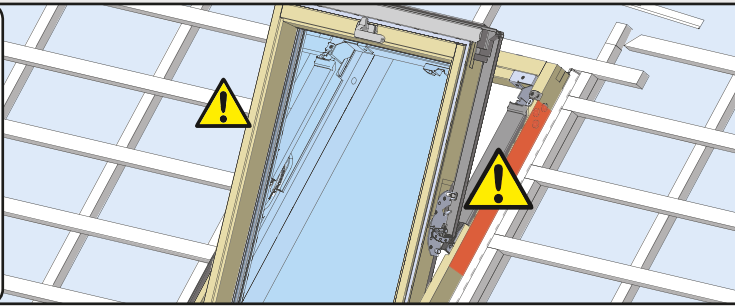

  
**TH/FE**

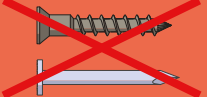

 

 max. 7 mm 

**32**

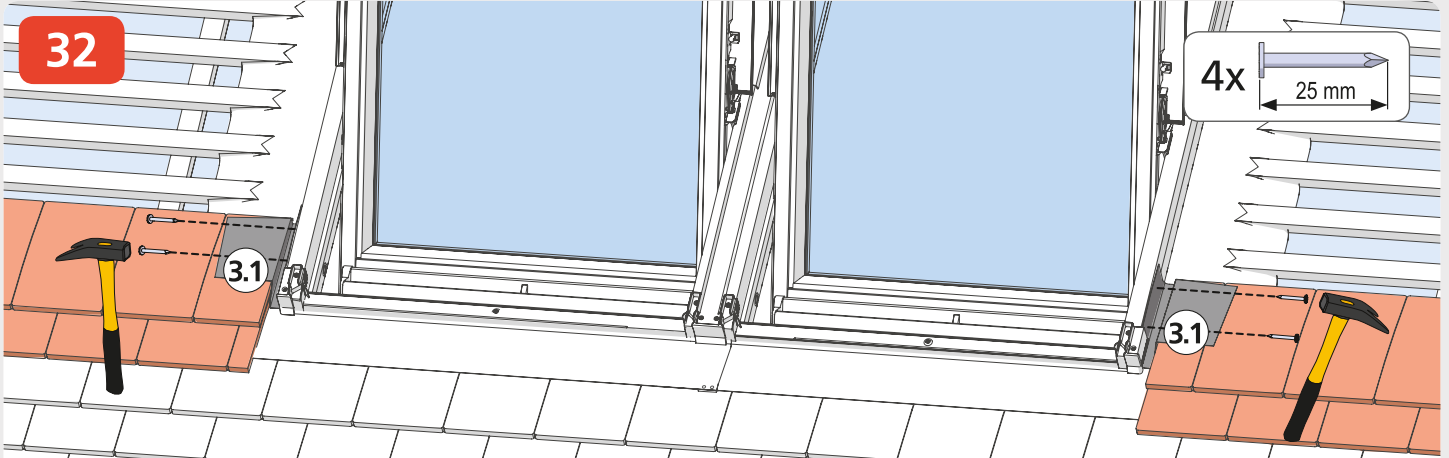

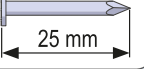

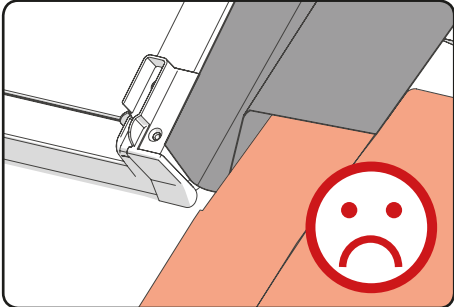
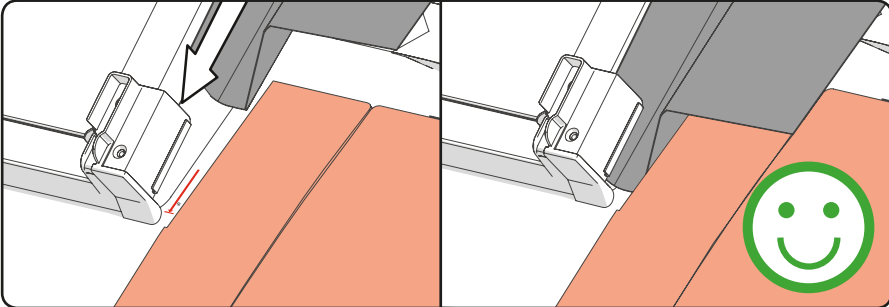
**4x**  25 mm

**33**

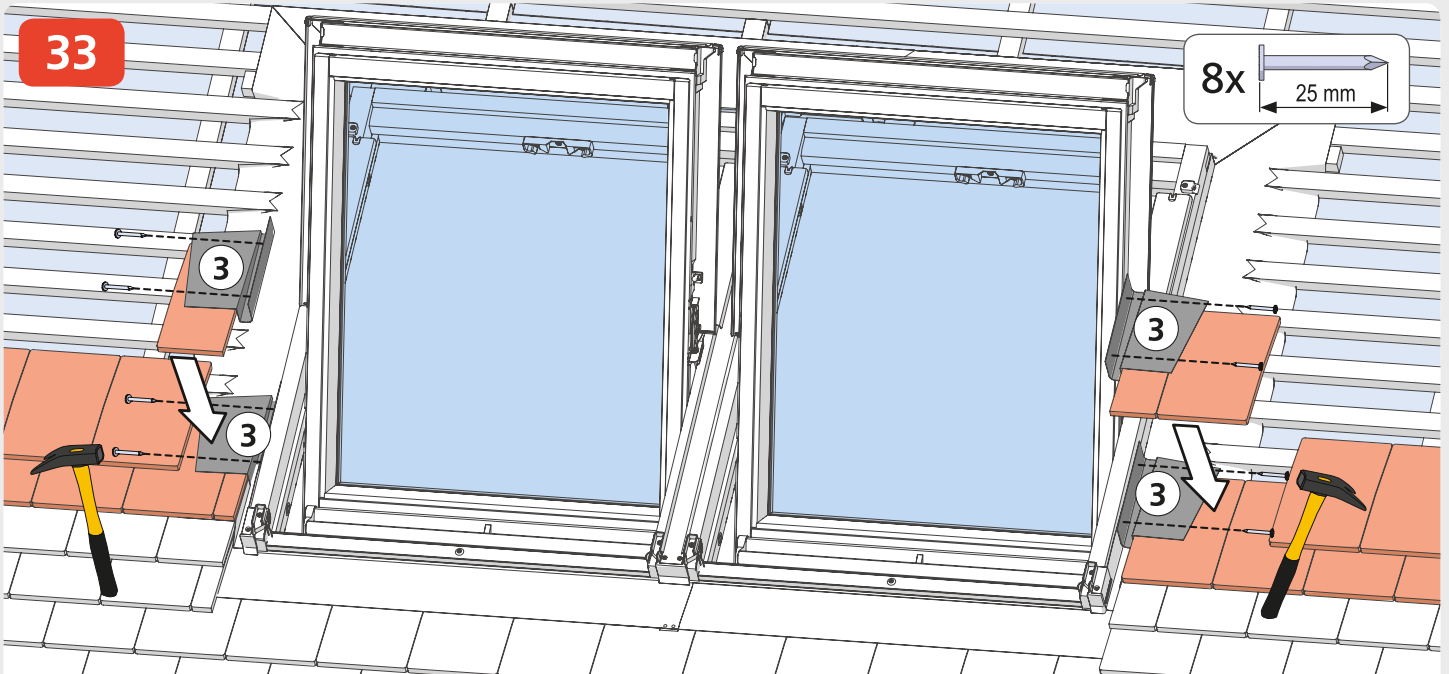

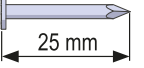
**8x**  25 mm

34

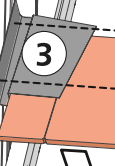
8x 25 mm

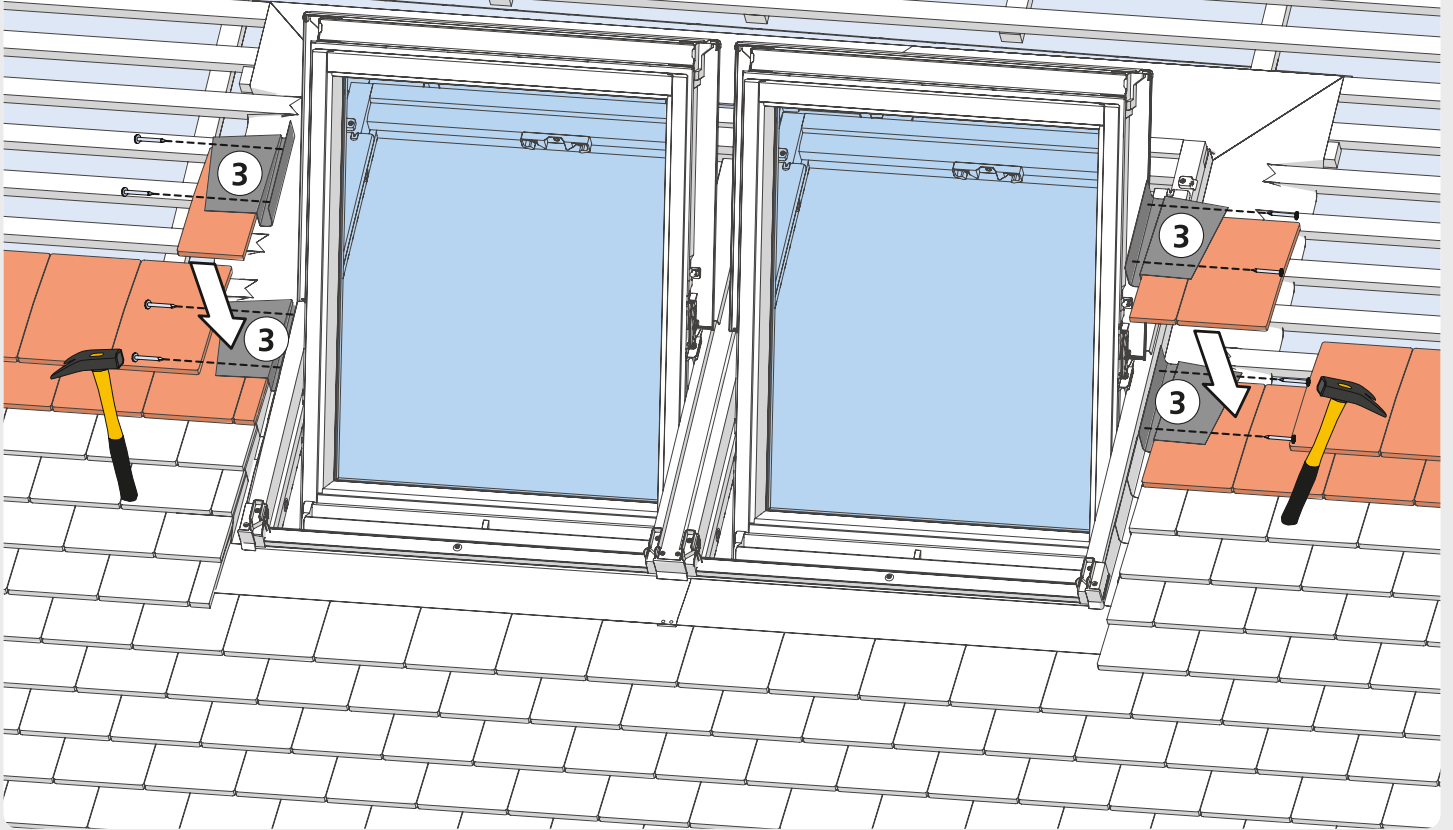

35

8x 25 mm

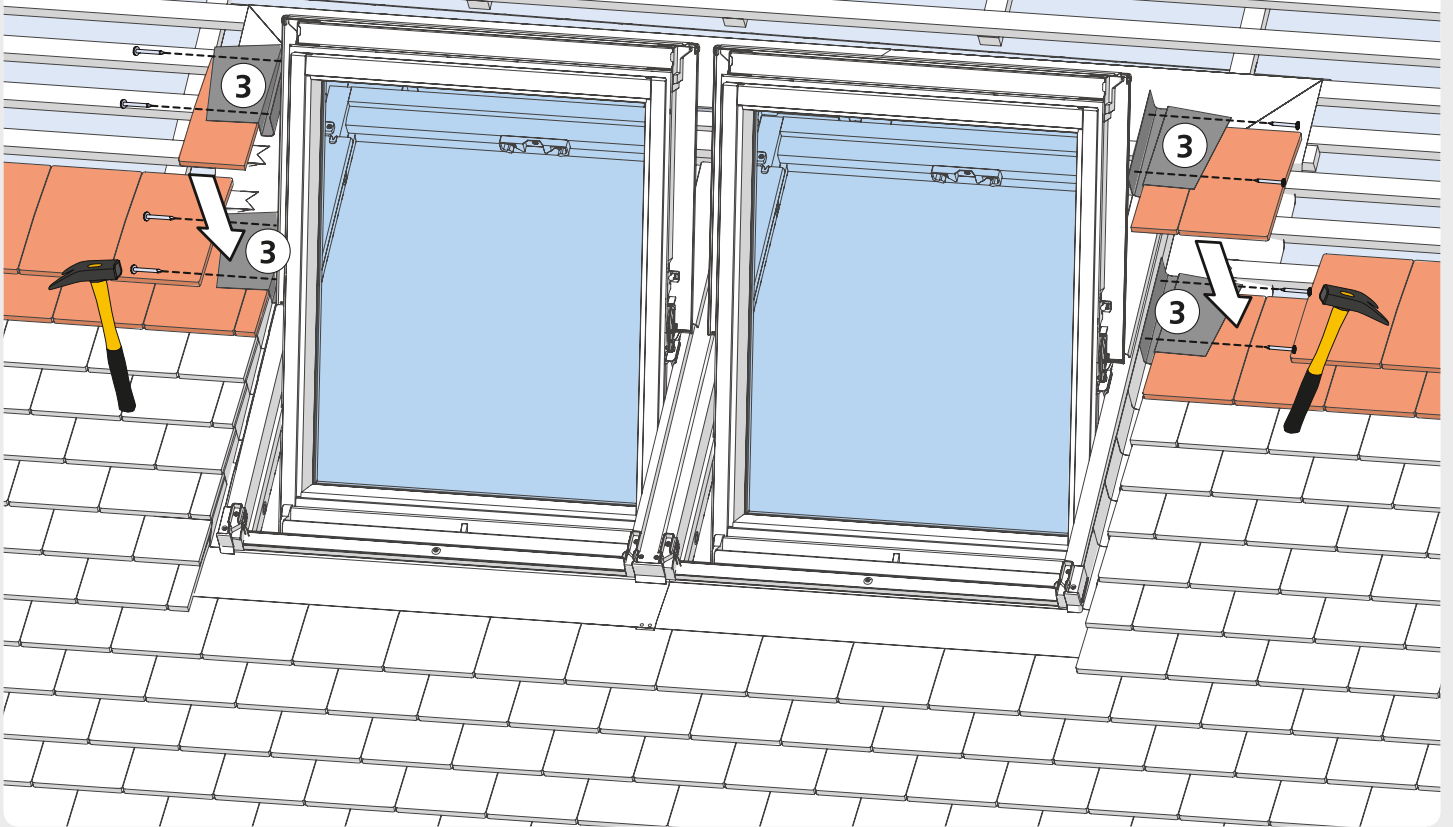

36

4x 25 mm

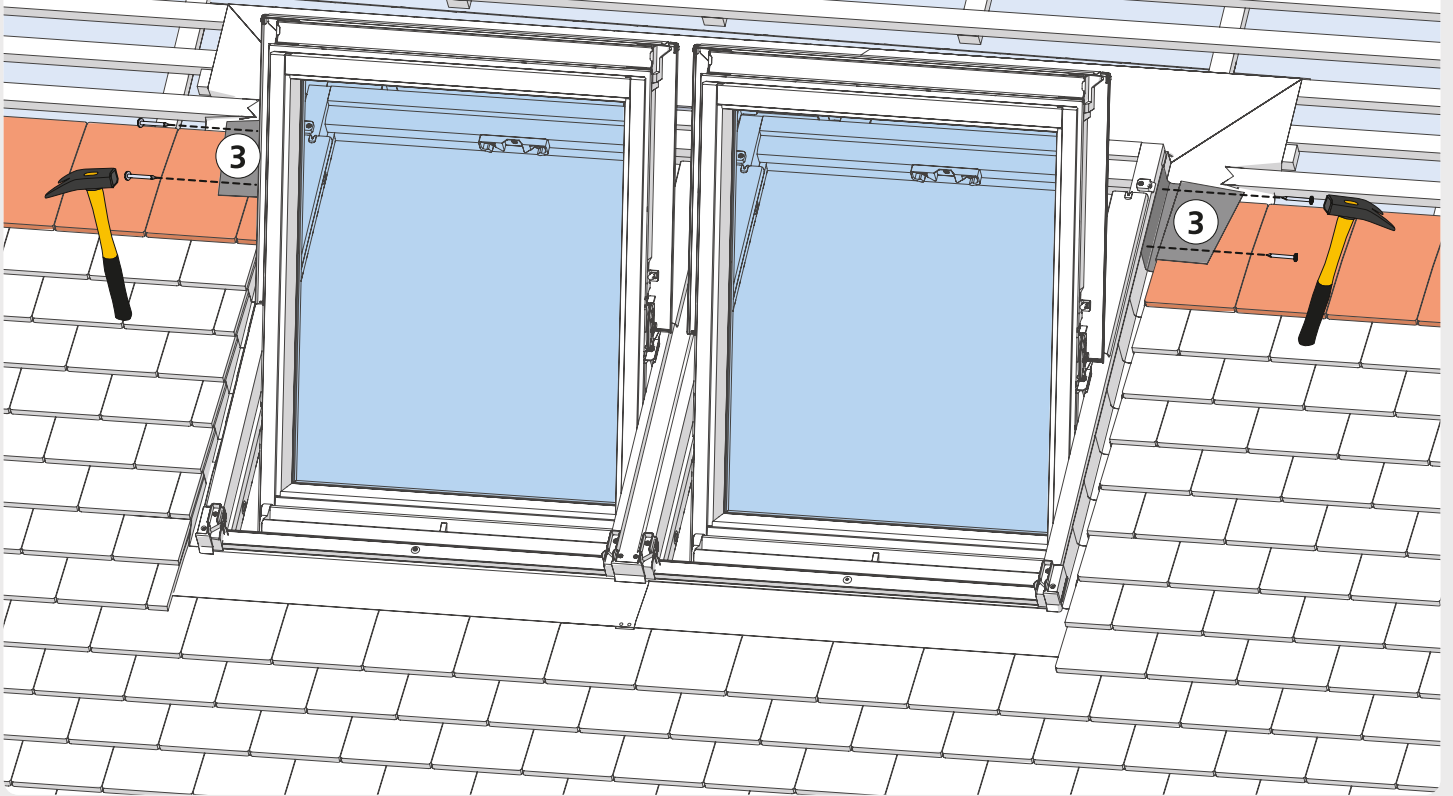

37

2x 30 mm

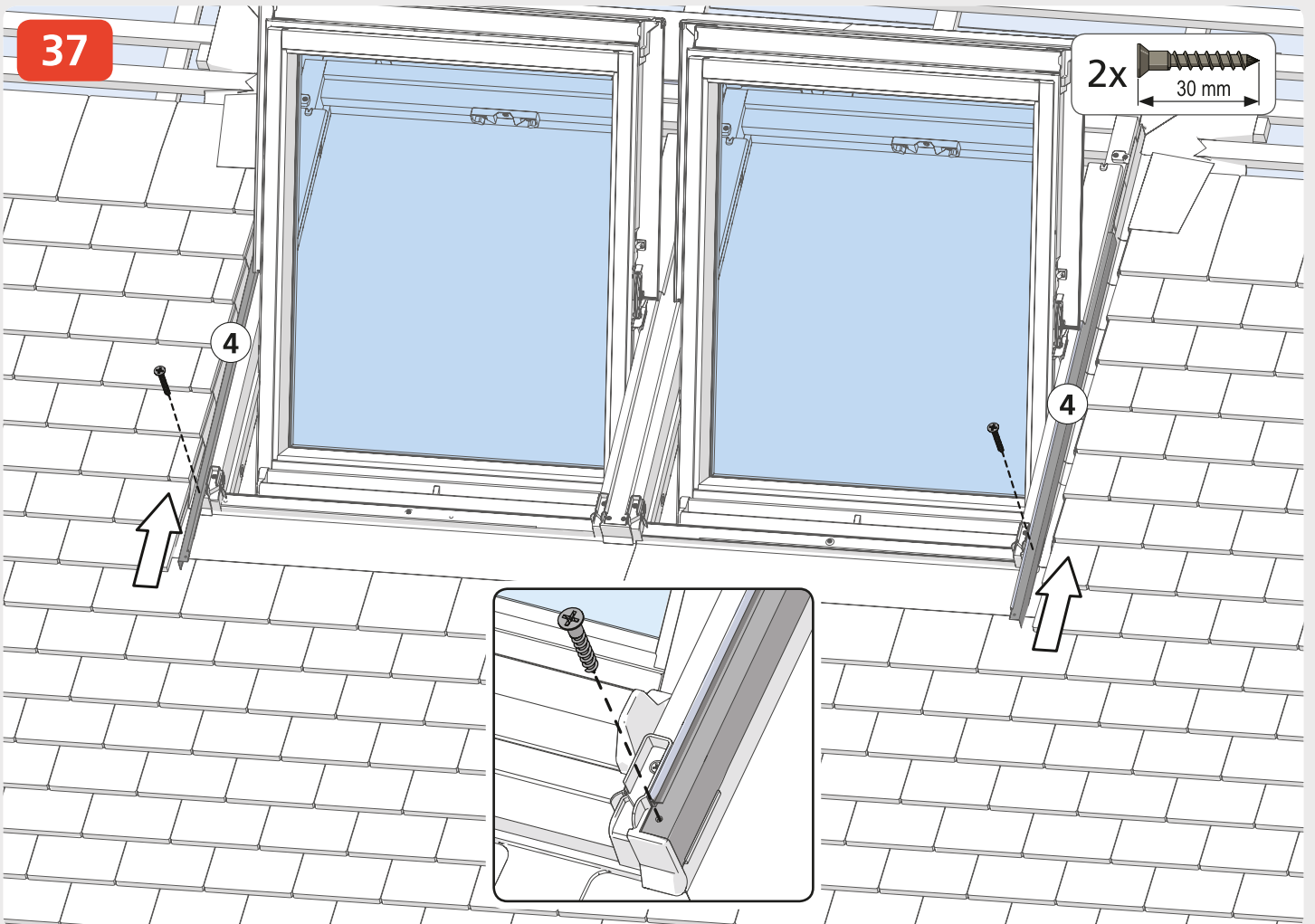

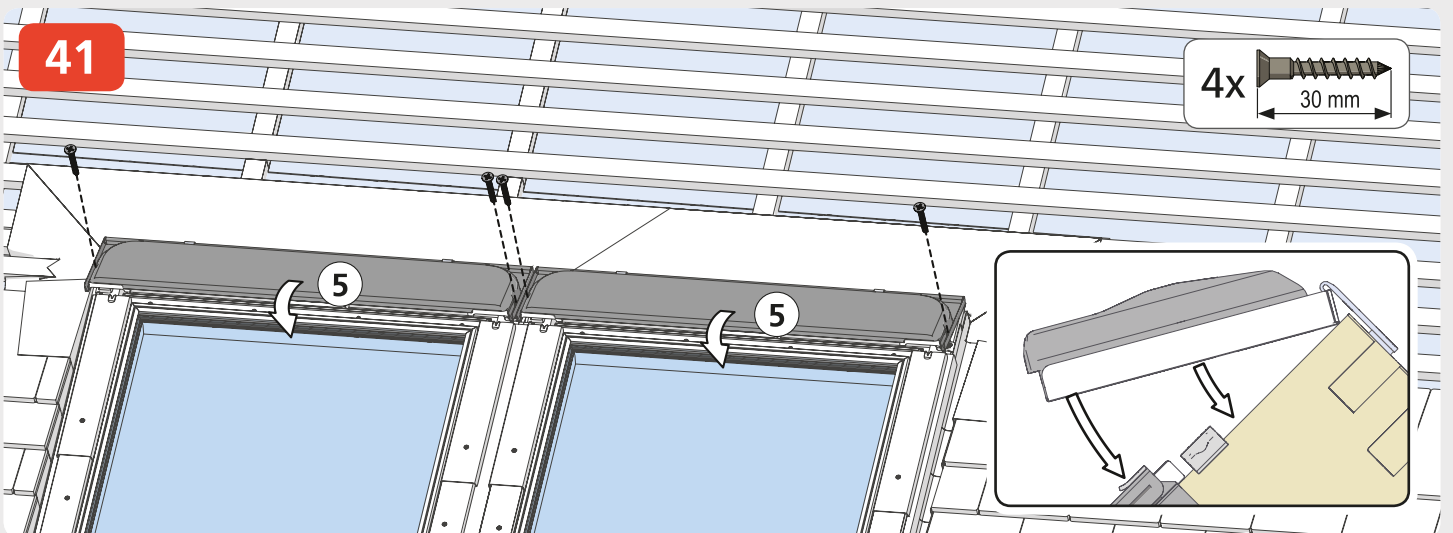
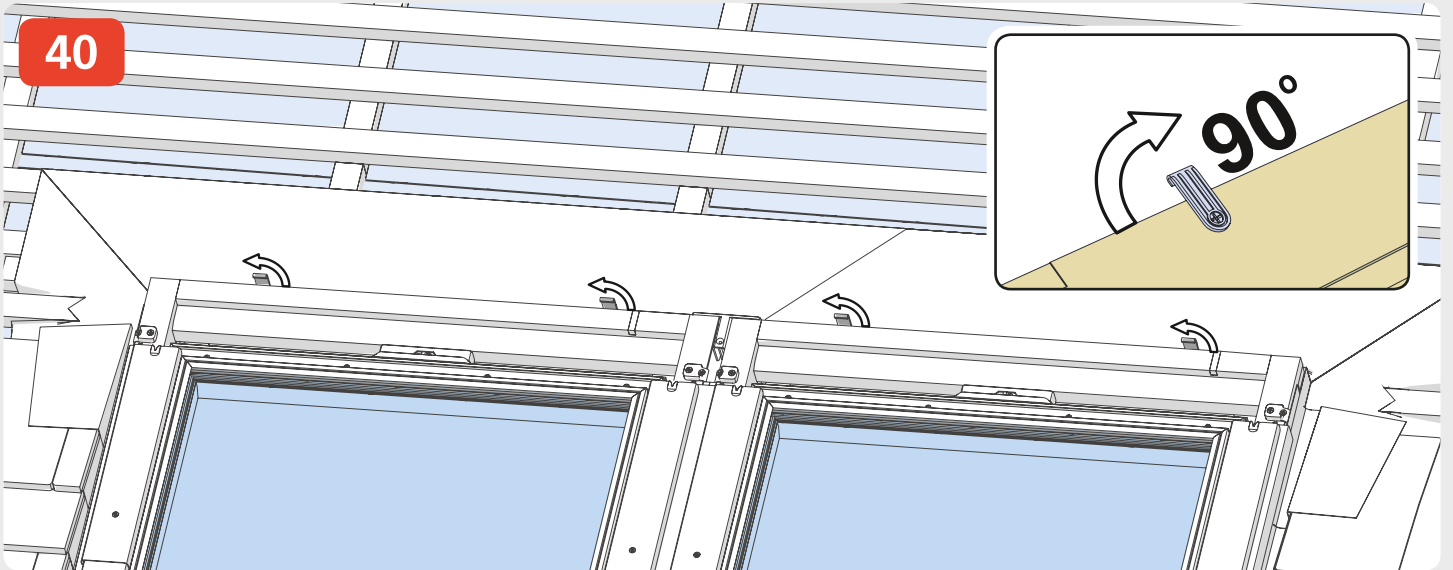
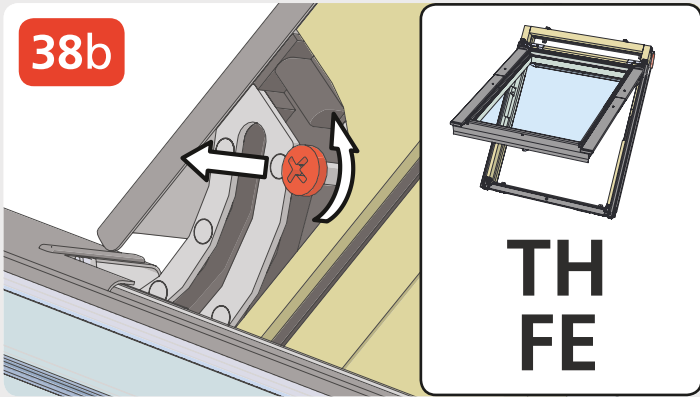
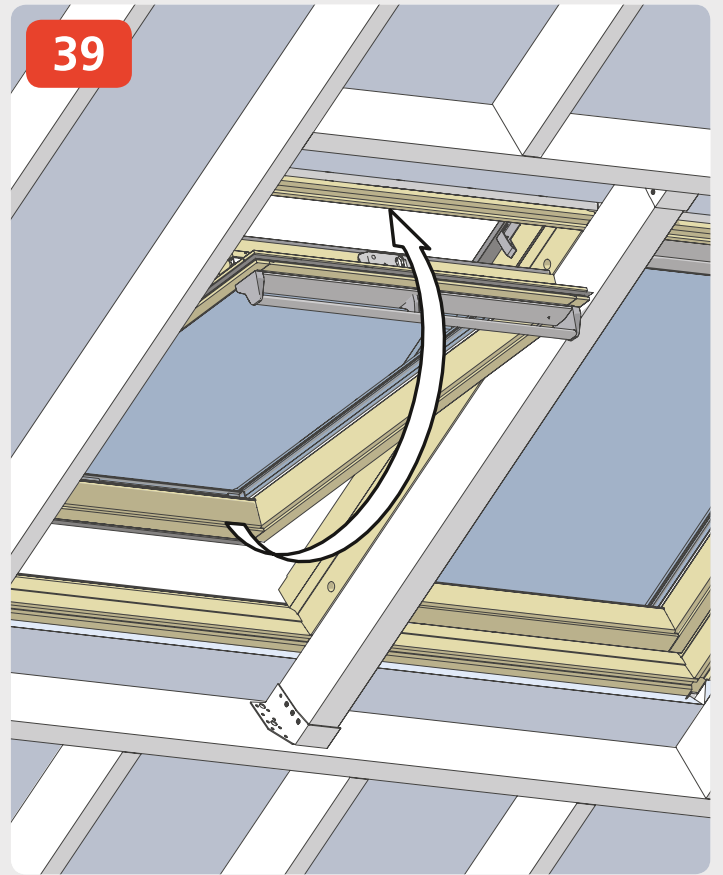
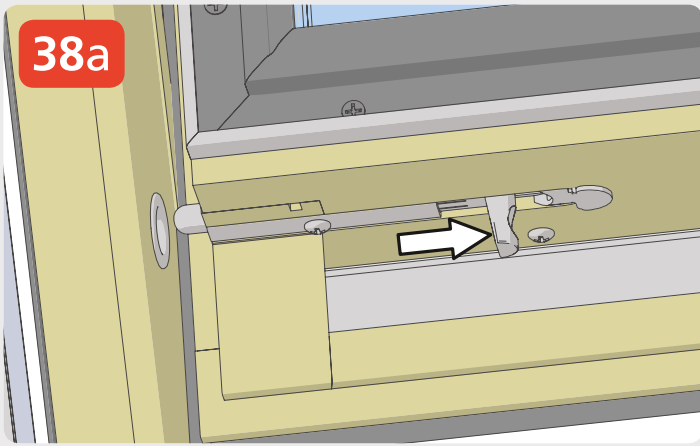



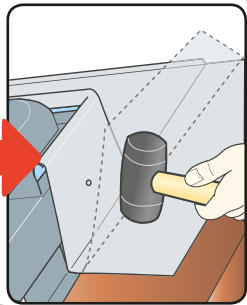
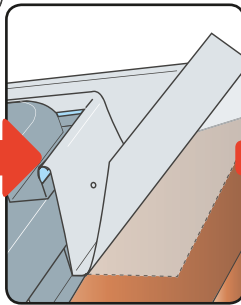
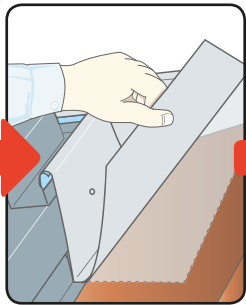
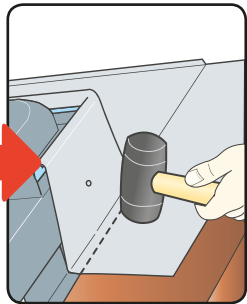
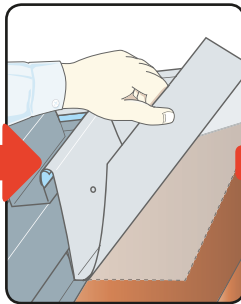
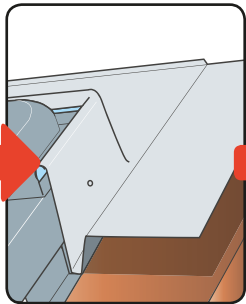
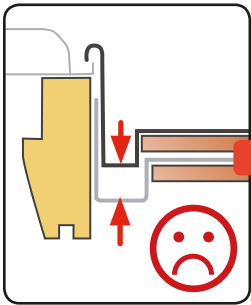
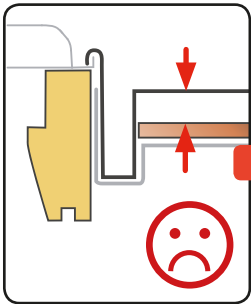
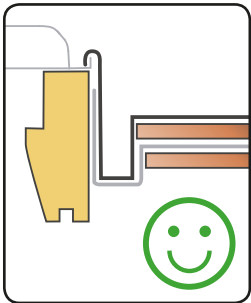
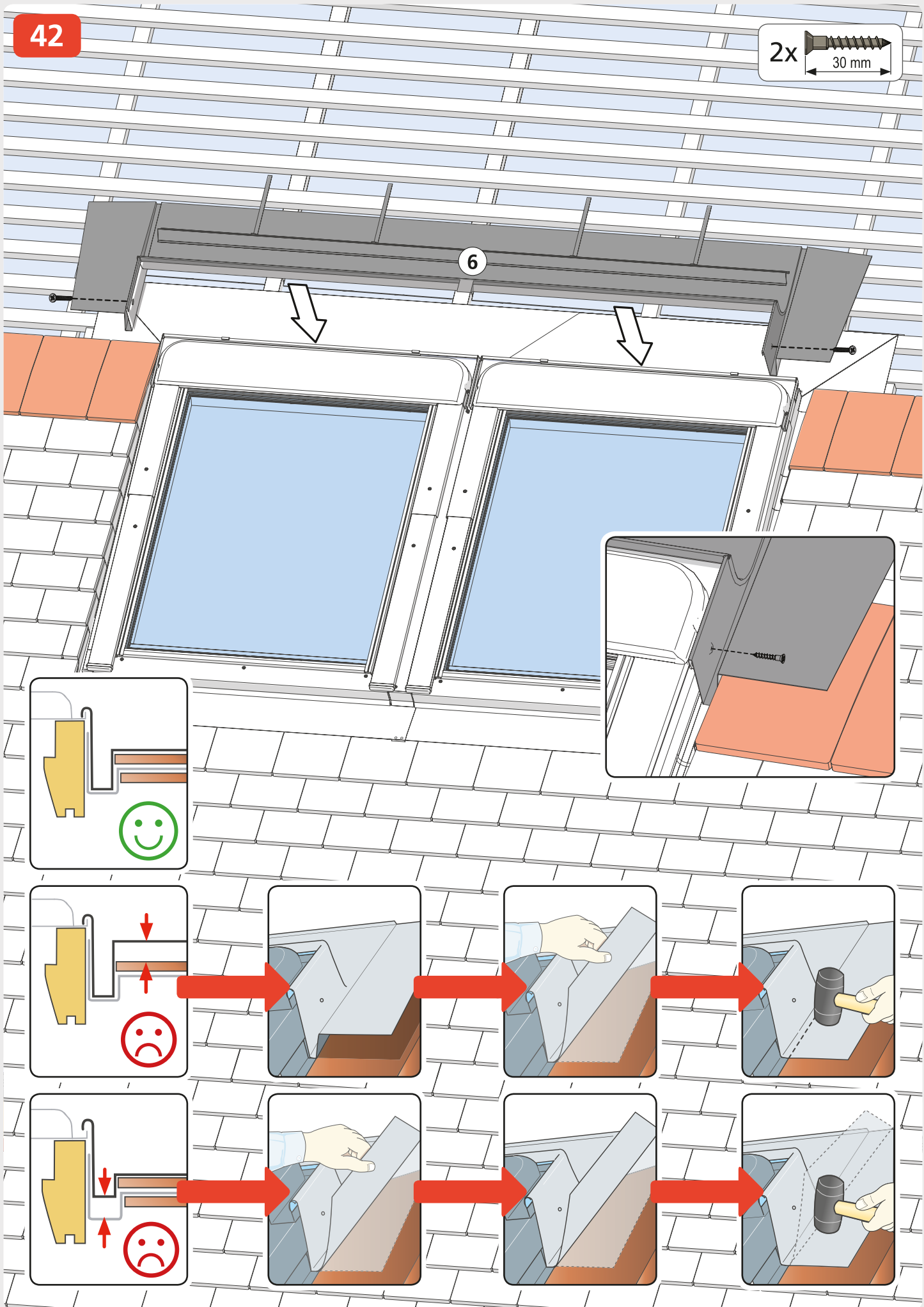

43

1x  60 mm

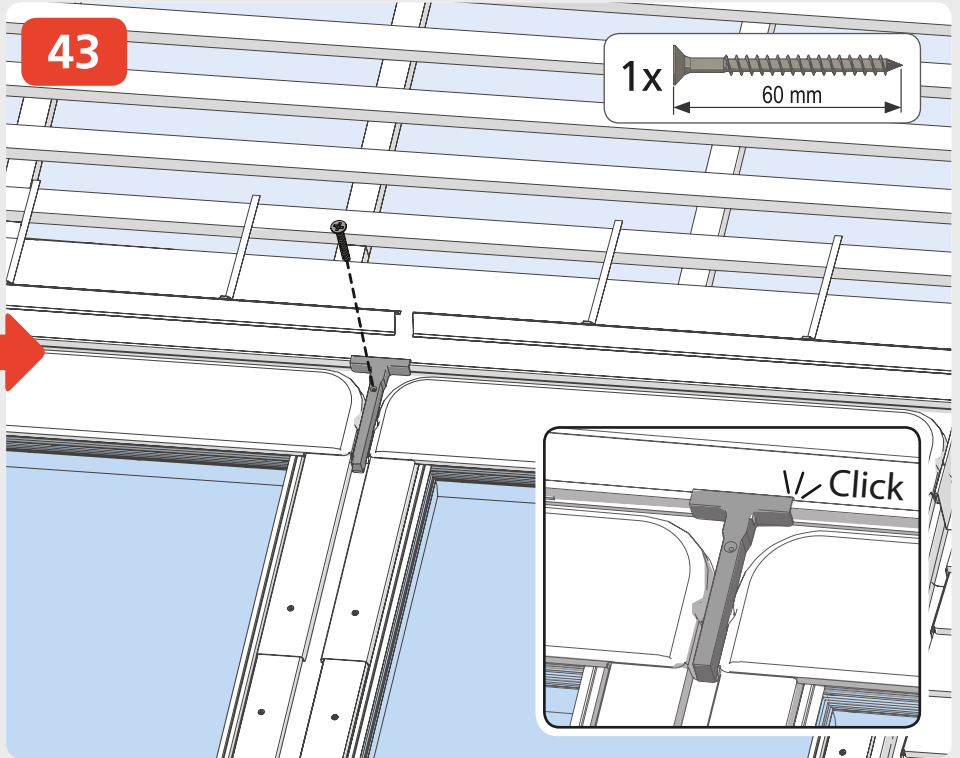
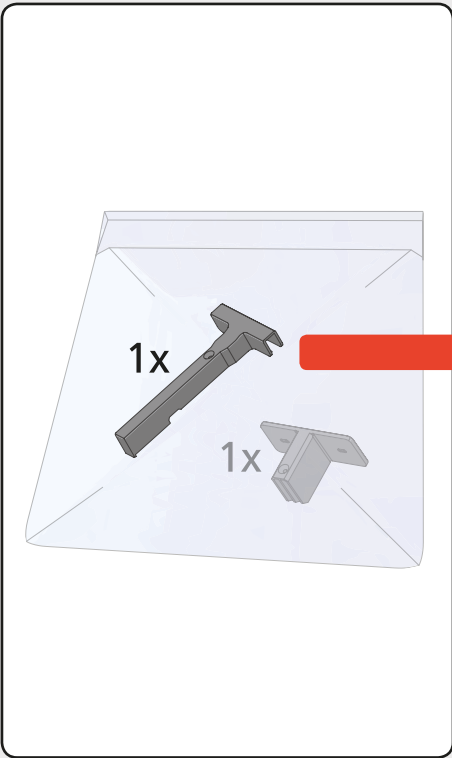

44

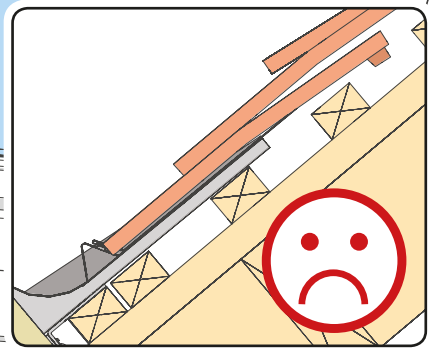
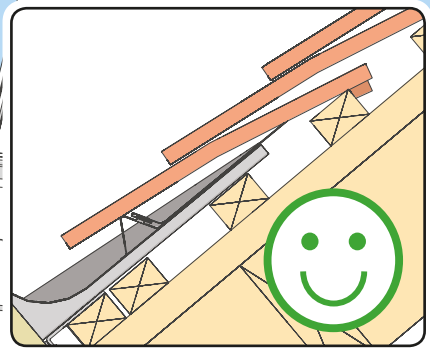
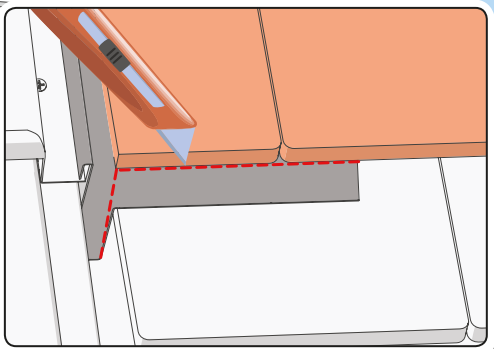
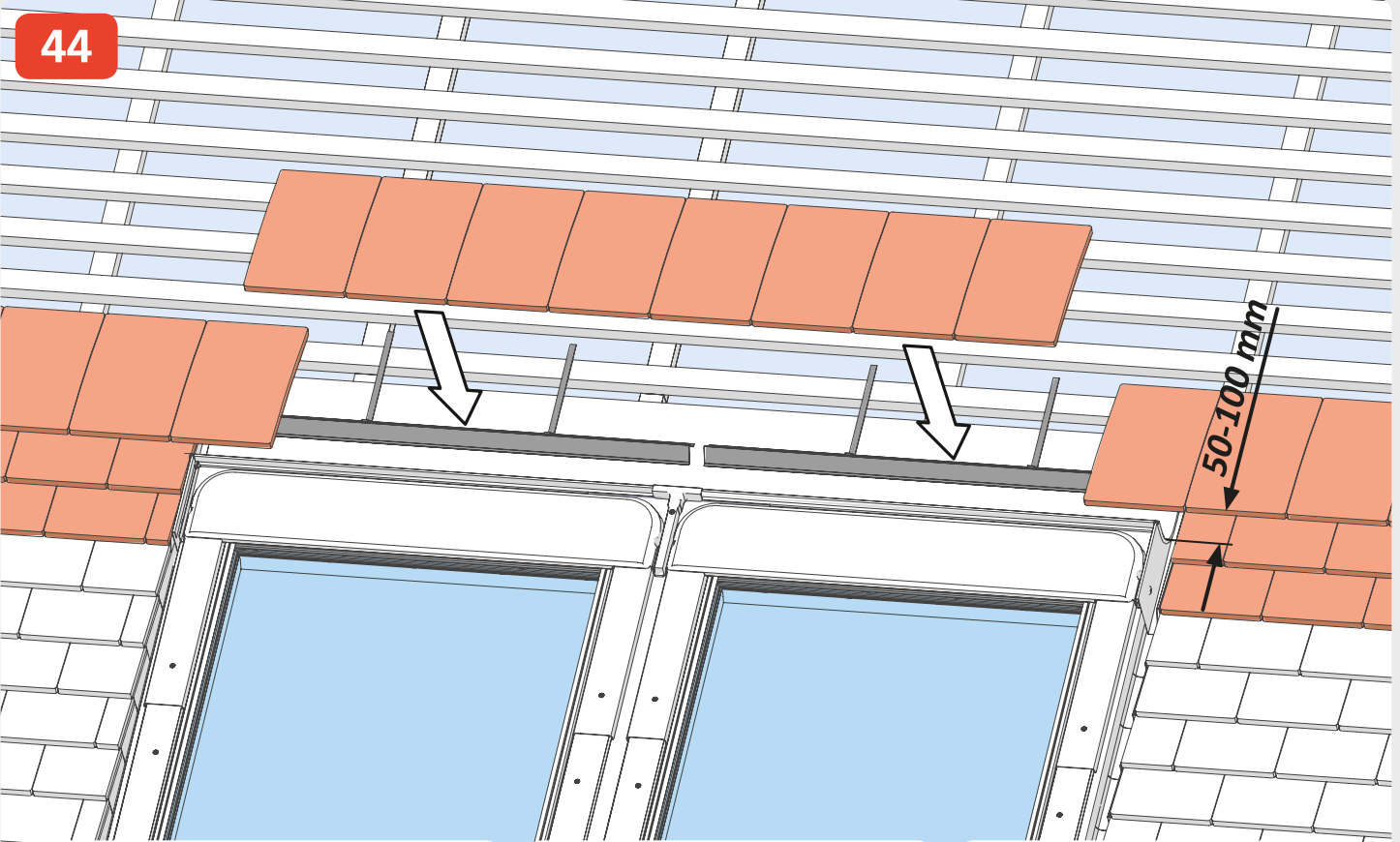

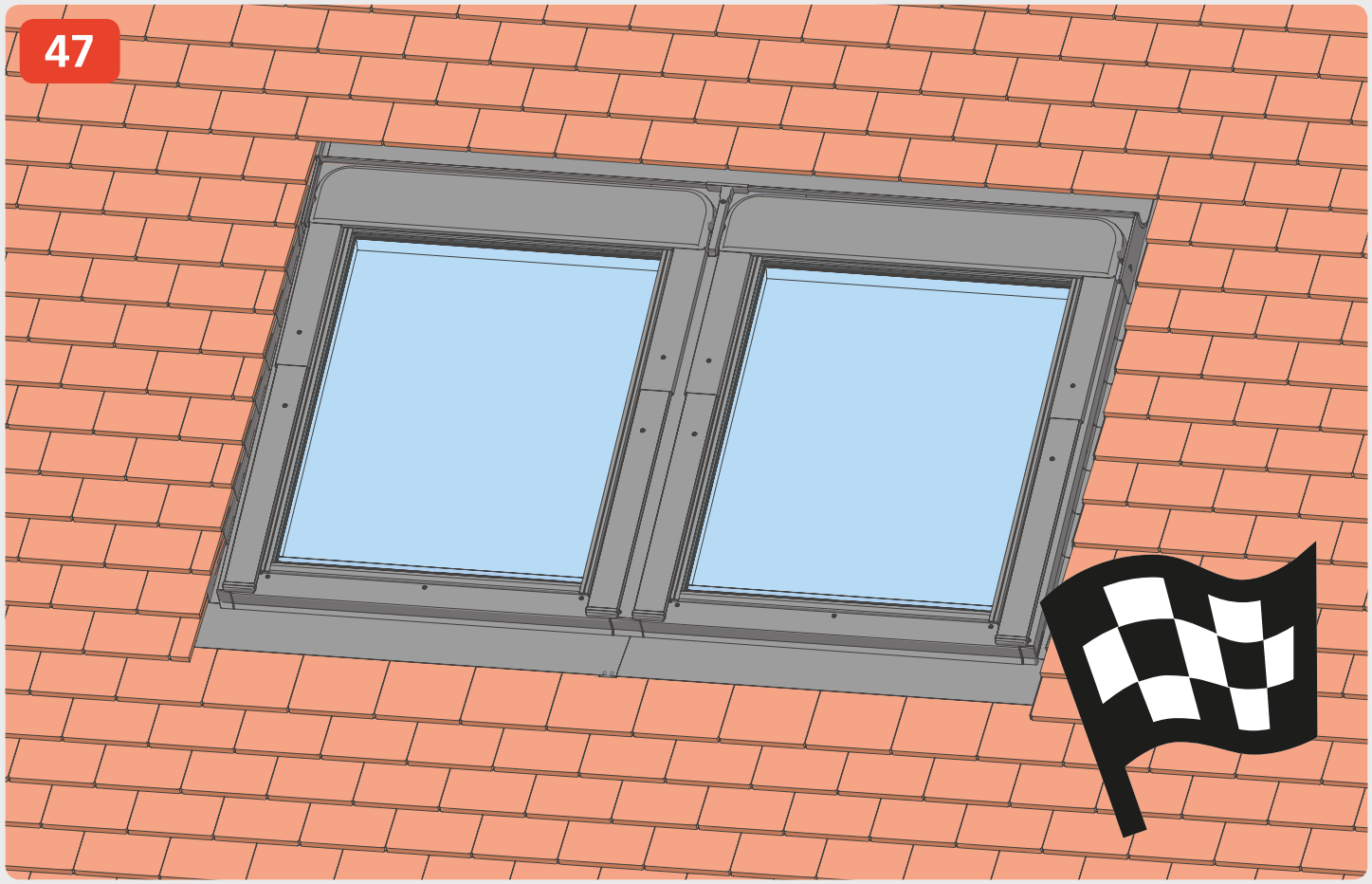
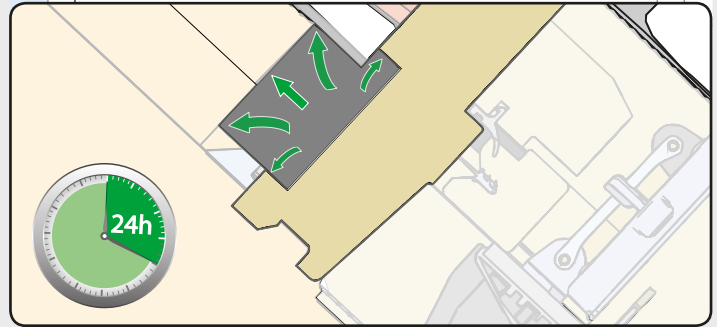
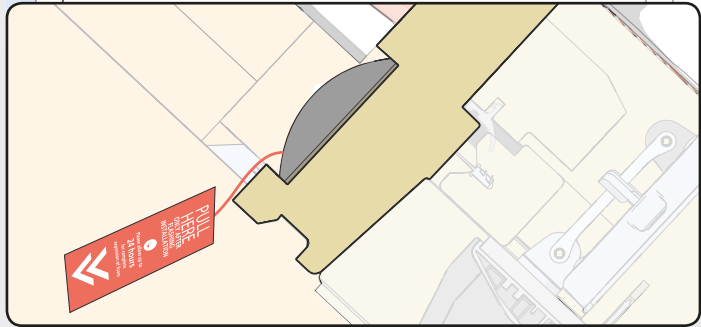
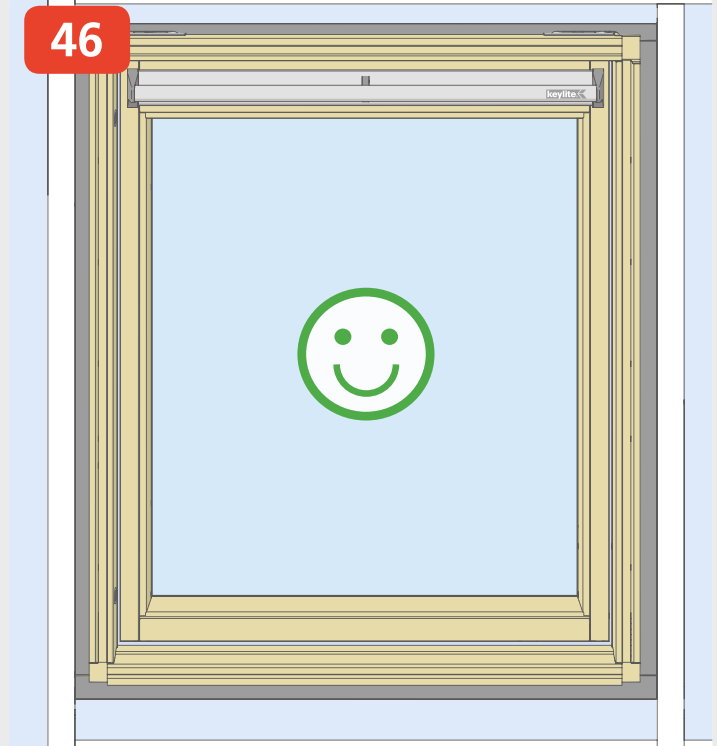
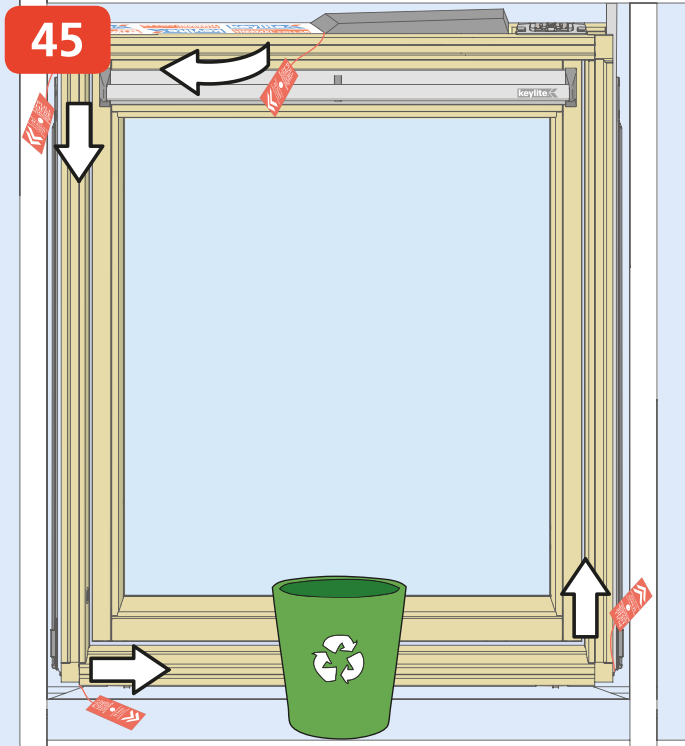



[www.keyliteroofwindows.com](http://www.keyliteroofwindows.com)